







BUILT-IN OVEN

[en] INSTRUCTION MANUAL

B25CR22.1

Table of contents

| | | | | | |
|--|--|-----------|---|---|-----------|
|  | Intended use | 4 |  | Sabbath mode | 17 |
|  | Important safety information | 4 | Starting Sabbath mode.....17 | | |
| General information | | 4 | Cancelling Sabbath mode | | |
| Halogen lamp..... | | 5 | 17 | | |
| Cleaning function | | 5 |  | Cleaning agent | 18 |
|  | Causes of damage | 6 | Suitable cleaning agents | | |
| General information | | 6 | Keeping the appliance clean | | |
|  | Environmental protection | 7 | 19 | | |
| Saving energy | | 7 |  | Cleaning function | 19 |
| Environmentally-friendly disposal | | 7 | Self-cleaning | | |
|  | Getting to know your appliance | 8 | EasyClean | | |
| Control panel | | 8 | 21 | | |
| Controls | | 8 |  | Rails | 22 |
| Main menu | | 9 | Detaching and refitting the rails | | |
| Menu for the types of heating | | 9 | 22 | | |
| Cooking compartment functions | | 10 |  | Appliance door | 22 |
|  | Accessories | 10 | Removing and fitting the appliance door | | |
| Accessories included | | 10 | Removing the door cover | | |
| Inserting accessories | | 10 | Removing and installing the door panels | | |
| Combining accessories | | 11 | 23 | | |
| Optional accessories | | 11 |  | Trouble shooting | 25 |
|  | Before using for the first time | 12 | Fault table | | |
| Initial use | | 12 | Maximum operating time exceeded | | |
| Cleaning the cooking compartment | | 12 | Replacing the bulb in the top of the cooking | | |
| Cleaning the accessories | | 12 | compartment | | |
|  | Operating the appliance | 13 | Glass cover | | |
| Switching the appliance on and off | | 13 | 26 | | |
| Setting and starting the appliance operation | | 13 |  | Customer service | 26 |
| Changing or cancelling the appliance operation | | 13 | E number and FD number | | |
| Heating up the appliance quickly | | 14 | 26 | | |
|  | Time-setting options | 14 |  | Tested for you in our cooking studio | 27 |
| Showing and hiding the time-setting options | | 14 | Silicone moulds | | |
| Setting the timer | | 14 | Cakes and small baked items | | |
| Setting the cooking time | | 15 | Bread and rolls | | |
| Start delay – "Ready at" | | 15 | Pizza, quiche and savoury cakes | | |
| Checking, changing or deleting settings | | 15 | Bakes and soufflés | | |
|  | Childproof lock | 15 | Poultry | | |
| Automatic childproof lock | | 15 | Meat | | |
| One-time childproof lock | | 16 | Fish | | |
|  | Basic settings | 16 | Vegetables and side dishes | | |
| Changing the basic settings | | 16 | Yogurt | | |
| List of basic settings | | 16 | Eco heating functions | | |
| Setting favourites | | 17 | Acrylamide in foodstuffs | | |
| | | | Slow cook | | |
| | | | Drying | | |
| | | | Preserving | | |
| | | | Allowing the dough to prove at dough proving | | |
| | | | setting | | |
| | | | 45 | | |
| | | | Defrosting | | |
| | | | 45 | | |
| | | | Keeping warm | | |
| | | | 46 | | |
| | | | Test dishes | | |
| | | | 46 | | |

Additional information on products, accessories, replacement parts and services can be found at www.neff-international.com and in the online shop www.neff-eshop.com

Intended use

Read these instructions carefully. Only then will you be able to operate your appliance safely and correctly. Retain the instruction manual and installation instructions for future use or for subsequent owners.

This appliance is only intended to be fully fitted in a kitchen. Observe the special installation instructions.

Check the appliance for damage after unpacking it. Do not connect the appliance if it has been damaged in transport.

Only a licensed professional may connect appliances without plugs. Damage caused by incorrect connection is not covered under warranty.

This appliance is intended for domestic use only. The appliance must only be used for the preparation of food and drink. The appliance must be supervised during operation. Only use this appliance indoors.

This appliance is intended for use up to a maximum height of 4000 metres above sea level.

This appliance may be used by children over the age of 8 years old and by persons with reduced physical, sensory or mental capabilities or by persons with a lack of experience or knowledge if they are supervised or are instructed by a person responsible for their safety how to use the appliance safely and have understood the associated hazards.

Children must not play with, on, or around the appliance. Children must not clean the appliance or carry out general maintenance unless they are at least 15 years old and are being supervised.

Keep children below the age of 8 years old at a safe distance from the appliance and power cable.

Always slide accessories into the cooking compartment the right way round.

→ "Accessories" on page 10

Important safety information

General information

Warning – Risk of fire!

- Combustible items stored in the cooking compartment may catch fire. Never store combustible items in the cooking compartment. Never open the appliance door if there is smoke inside. Switch off the appliance and unplug it from the mains or switch off the circuit breaker in the fuse box.
- Loose food remnants, fat and meat juices may catch fire. Before using the appliance, remove the worst of the food remnants from the cooking compartment, heating elements and accessories.
- A draught is created when the appliance door is opened. Greaseproof paper may come into contact with the heating element and catch fire. Do not place greaseproof paper loosely over accessories during preheating. Always weight down the greaseproof paper with a dish or a baking tin. Only cover the surface required with greaseproof paper. Greaseproof paper must not protrude over the accessories.

Warning – Risk of burns!

- The appliance becomes very hot. Never touch the interior surfaces of the cooking compartment or the heating elements. Always allow the appliance to cool down. Keep children at a safe distance.
- Accessories and ovenware become very hot. Always use oven gloves to remove accessories or ovenware from the cooking compartment.
- Alcoholic vapours may catch fire in the hot cooking compartment. Never prepare food containing large quantities of drinks with a high alcohol content. Only use small quantities of drinks with a high alcohol content. Open the appliance door with care.

Warning – Risk of scalding!

- The accessible parts become hot during operation. Never touch the hot parts. Keep children at a safe distance.
- When you open the appliance door, hot steam can escape. Steam may not be visible, depending on its temperature. When opening, do not stand too close to the appliance. Open the appliance door carefully. Keep children away.
- Water in a hot cooking compartment may create hot steam. Never pour water into the hot cooking compartment.

⚠ Warning – Risk of injury!

- Scratched glass in the appliance door may develop into a crack. Do not use a glass scraper, sharp or abrasive cleaning aids or detergents.
- The hinges on the appliance door move when opening and closing the door, and you may be trapped. Keep your hands away from the hinges.

⚠ Warning – Risk of electric shock!

- Incorrect repairs are dangerous. Repairs may only be carried out and damaged power cables replaced by one of our trained after-sales technicians. If the appliance is defective, unplug the appliance from the mains or switch off the circuit breaker in the fuse box. Contact the after-sales service.
- The cable insulation on electrical appliances may melt when touching hot parts of the appliance. Never bring electrical appliance cables into contact with hot parts of the appliance.
- Do not use any high-pressure cleaners or steam cleaners, which can result in an electric shock.
- A defective appliance may cause electric shock. Never switch on a defective appliance. Unplug the appliance from the mains or switch off the circuit breaker in the fuse box. Contact the after-sales service.

⚠ Warning – Hazard due to magnetism!

Permanent magnets are used in the control panel or in the control elements. They may affect electronic implants, e.g. heart pacemakers or insulin pumps. Wearers of electronic implants must stay at least 10 cm away from the control panel.

Halogen lamp**⚠ Warning – Risk of burns!**

The bulbs in the cooking compartment become very hot. There is still a risk of burning your skin for some time after they have been switched off. Do not touch the glass cover. Avoid contact with your skin when cleaning.

⚠ Warning – Risk of electric shock!

When replacing the cooking compartment bulb, the bulb socket contacts are live. Before replacing the bulb, unplug the appliance from the mains or switch off the circuit breaker in the fuse box.

Cleaning function**⚠ Warning – Risk of fire!**

- Loose food residues, grease and meat juices may catch fire during the cleaning function. Before starting the cleaning function, remove coarse dirt from the cooking compartment and from the accessories.
- The appliance will become very hot on the outside during the cleaning function. Never hang combustible objects, e.g. tea towels, on the door handle. Do not place anything against the front of the appliance. Keep children away from the appliance.

⚠ Warning – Risk of serious damage to health!

The appliance will become very hot during the cleaning function. The non-stick coating on baking trays and tins is destroyed and noxious gases are released. Never clean non-stick baking trays and baking tins using the cleaning function. Only clean enamelled accessories using the cleaning function.

⚠ Warning – Risk of harm to health!

The cleaning function heats up the cooking compartment to a very high temperature so that food remnants left over from roasting, grilling and baking will burn off. This process releases vapours, which can irritate the mucous membranes. While the cleaning function is running, keep the kitchen well ventilated. Do not remain in the room for long periods. Keep children and pets away. Follow the instructions even when using the Delayed start function with a delayed end time.

⚠ Warning – Risk of burns!

- The cooking compartment becomes extremely hot during the cleaning function. Never open the appliance door. Allow the appliance to cool down. Keep children away from the appliance.
- ⚠ The appliance will become very hot on the outside during the cleaning function. Never touch the appliance door. Allow the appliance to cool down. Keep children away from the appliance.

Causes of damage

General information

Caution!

- Accessories, foil, greaseproof paper or ovenware on the cooking compartment floor: do not place accessories on the cooking compartment floor. Do not cover the cooking compartment floor with any sort of foil or greaseproof paper. Do not place ovenware on the cooking compartment floor if a temperature of over 50 °C has been set. This will cause heat to accumulate. The baking and roasting times will no longer be correct and the enamel will be damaged.
- Aluminium foil: Aluminium foil in the cooking compartment must not come into contact with the door glass. This could cause permanent discolouration of the door glass.
- Water in a hot cooking compartment: do not pour water into the cooking compartment when it is hot. This will cause steam. The temperature change can cause damage to the enamel.
- Moisture in the cooking compartment: Over an extended period of time, moisture in the cooking compartment may lead to corrosion. Allow the cooking compartment to dry after use. Do not keep moist food in the closed cooking compartment for extended periods of time. Do not store food in the cooking compartment.
- Cooling with the appliance door open: Following operation at high temperatures, only allow the cooking compartment to cool down with the door closed. Do not trap anything in the appliance door. Even if the door is only left open a crack, the front of nearby furniture may become damaged over time. Only leave the cooking compartment to dry with the door open if a lot of moisture was produced whilst the oven was operating.
- Fruit juice: when baking particularly juicy fruit pies, do not pack the baking tray too generously. Fruit juice dripping from the baking tray leaves stains that cannot be removed. If possible, use the deeper universal pan.
- Extremely dirty seal: If the seal is very dirty, the appliance door will no longer close properly during operation. The fronts of adjacent units could be damaged. Always keep the seal clean.
- Appliance door as a seat, shelf or worktop: Do not sit on the appliance door, or place or hang anything on it. Do not place any cookware or accessories on the appliance door.
- Inserting accessories: depending on the appliance model, accessories can scratch the door panel when closing the appliance door. Always insert the accessories into the cooking compartment as far as they will go.
- Carrying the appliance: do not carry or hold the appliance by the door handle. The door handle cannot support the weight of the appliance and could break.

Environmental protection

Your new appliance is particularly energy-efficient. Here you can find tips on how to save even more energy when using the appliance, and how to dispose of your appliance properly.

Saving energy

- Only preheat the appliance if this is specified in the recipe or in the tables in the operating instructions.
- Leave frozen food to defrost before placing it in the cooking compartment.

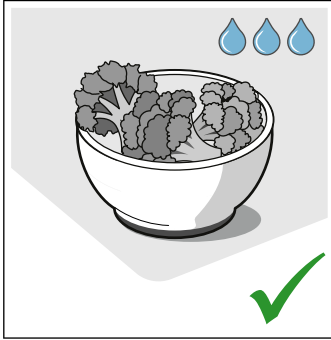
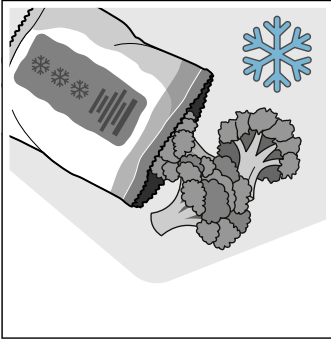

- Use baking tins that are dark-coloured, painted black or have an enamel coating. These absorb the heat particularly well.

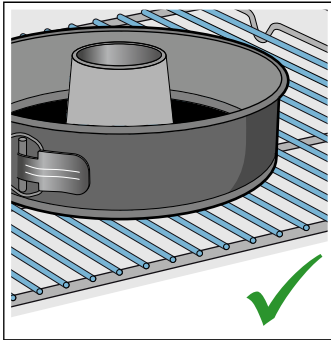
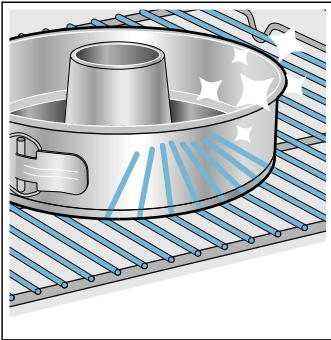

- Remove any unnecessary accessories from the cooking compartment.

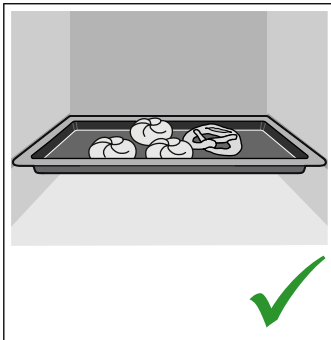
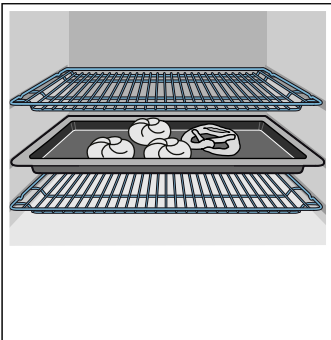

- Open the appliance door as infrequently as possible when the appliance is in use.



- It is best to bake several cakes one after the other. The cooking compartment stays warm. This reduces the baking time for the second cake. You can place two cake tins next to each other in the cooking compartment.



- For longer cooking times, you can switch the appliance off 10 minutes before the end of the cooking time and use the residual heat to finish cooking.

Environmentally-friendly disposal

Dispose of packaging in an environmentally-friendly manner.



This appliance is labelled in accordance with European Directive 2012/19/EU concerning used electrical and electronic appliances (waste electrical and electronic equipment - WEEE). The guideline determines the framework for the return and recycling of used appliances as applicable throughout the EU.

Getting to know your appliance

In this chapter, we will explain the indicators and controls. You will also find out about the various functions of your appliance.

Note: Depending on the appliance model, individual details and colours may differ.

Control panel

In the control panel, set the appliance's different functions. The current settings are shown on the display.

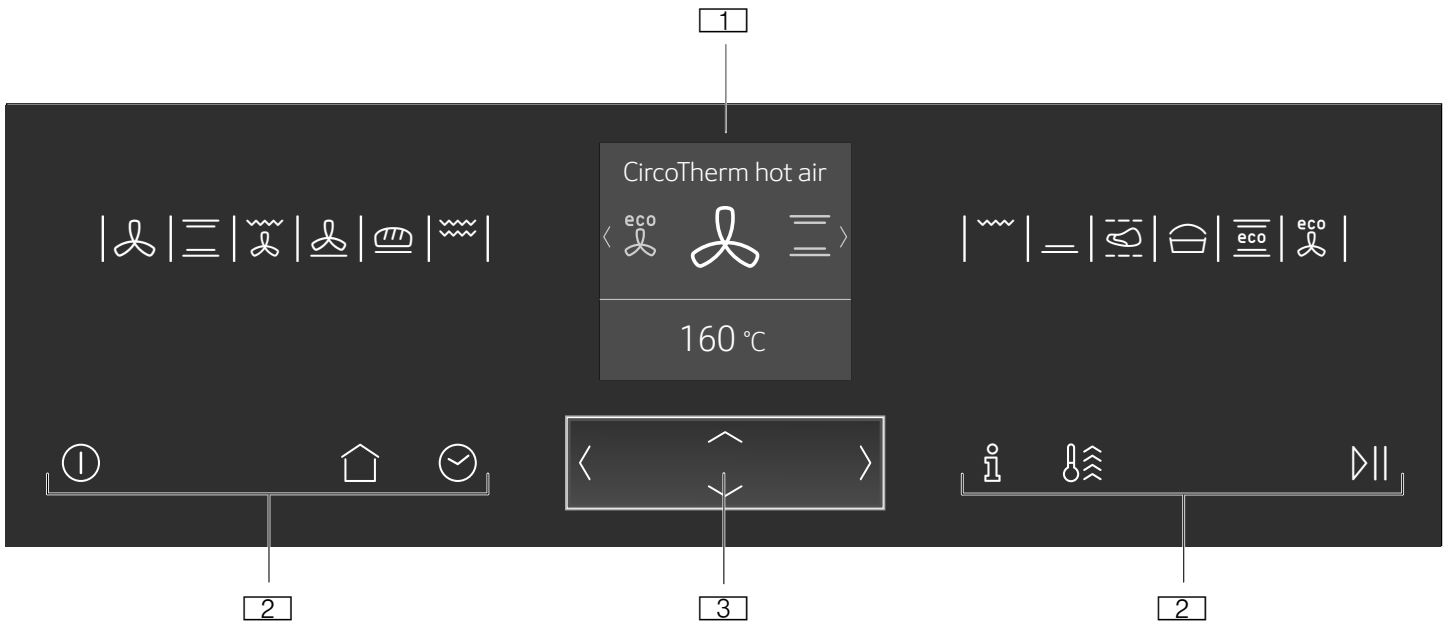

- 1 Display
- 2 Touch buttons
- 3 ShiftControl control

Controls

Use the controls to set your appliance simply and directly.

Touch buttons

There are sensors under the touch buttons. Touch on the corresponding touch button to select a function.

| Touch button | Use |
|------------------------|--|
| ⓘ on/off | Switching the appliance on or off → "Switching the appliance on and off" on page 13 |
| 🏠 Main menu | Selecting operating modes and settings → "Setting and starting the appliance operation" on page 13 |
| 🕒 Time-setting options | Setting the timer, cooking time, or "Ready at" start delay → "Time-setting options" on page 14 |
| 🔒 Childproof lock | Activating or deactivating the childproof lock → "Childproof lock" on page 15 |
| ℹ Information | Displaying further information Displaying the current temperature → "Setting and starting the appliance operation" on page 13 |

| | |
|-----------------|--|
| ⚡ Rapid heating | Activating or deactivating rapid heating → "Heating up the appliance quickly" on page 14 |
| ⚡ Power-Boost | Activating or deactivating Power-Boost → "Heating up the appliance quickly" on page 14 |
| ⏸ Start/Stop | Starting or stopping the operation → "Setting and starting the appliance operation" on page 13 |

ShiftControl control

Use the ShiftControl control element to navigate through the lines on the display and select the settings. Settings that you can change have left and right arrows < >.



| Button | Use |
|--------|--|
| < | Left Navigates to the left on the display |
| > | Right Navigates to the right on the display |
| ^ | Up Navigates upwards on the display |
| v | Down Navigates downwards on the display |

Note: You can also scroll through the settings values quickly by pressing and holding a button. As soon as you release the button, you stop scrolling through the values quickly.

Main menu

Touch the  touch button to access the main menu.

| Menu | Use |
|--|--|
|  | Types of heating Selecting the required type of heating and temperature for your dish → "Switching the appliance on and off" on page 13 |

| | |
|---|---|
|  | Basic settings Individually adjusting the appliance settings → "Basic settings" on page 16 |
|  | EasyClean Cleaning light soiling from the cooking compartment → "Cleaning function" on page 19 |
|  | Self-cleaning Cleaning the cooking compartment pyrolytically → "Cleaning function" on page 19 |

Menu for the types of heating

Your appliance has different types of heating. After switching on the appliance, you are taken directly to the menu for the types of heating.

| Type of heating | Temperature | Use |
|--|--------------|--|
|  CircoTherm | 40 - 200 °C | For baking and cooking on one or more levels. The fan distributes the heat from the ring heating element in the back panel evenly around the cooking compartment. |
|  Top/bottom heating | 50 - 275 °C | For traditional baking and roasting on one level. Especially suitable for cakes with moist toppings. Heat is emitted evenly from the top and bottom. |
|  Circo-roasting | 50 - 250 °C | For roasting poultry, whole fish and larger pieces of meat. The grill element and the fan switch on and off alternately. The fan circulates the hot air around the food. |
|  Circotherm intensive | 50 - 275 °C | For preparing pizza and dishes which require a lot of heat from underneath. The bottom heating element and the ring heating element in the back panel heat up. |
|  Bread-baking | 180 - 240 °C | For baking bread, bread rolls and baked items that require high temperatures. |
|  Full-surface grill | 50 - 290 °C | For grilling flat items, such as steaks or sausages, for making toast, and for au gratin dishes. The whole area below the grill element becomes hot. |
|  Centre-area grill | 50 - 290 °C | For grilling small amounts of steaks or sausages, for making toast, and for au gratin dishes. The centre area under the grill heating element becomes hot. |
|  Bottom heat | 50 - 250 °C | For cooking in a bain marie and for the final baking stage. The heat is emitted from below. |
|  Low temperature cooking | 70 - 120 °C | For gentle and slow cooking of seared, tender pieces of meat in ovenware without a lid. The heat is emitted evenly from the top and bottom at low temperatures. |
|  Dough proving | 35 - 55 °C | For leaving yeast dough and sourdough to prove and for culturing yogurt. Dough will prove more quickly than at room temperature. The surface of the dough does not dry out. |
|  Top/bottom heating eco | 50-275 °C | For gently cooking selected types of food. Heat is emitted from above and below. This heating function is most effective between 150 and 250 °C. This heating function is used to measure the energy consumption in the conventional mode. |
|  CircoTherm eco | 40-200 °C | For gently cooking selected types of food on one level without preheating. The fan distributes the heat from the ring-shaped heating element in the back panel around the cooking compartment. This heating function is most effective between 125 and 200 °C. This heating function is used to measure both the energy consumption in air recirculation mode and the energy efficiency class. |

Cooking compartment functions

The functions in the cooking compartment make your appliance easier to use. This, for example, enables the cooking compartment to be well lit and a cooling fan to prevent the appliance from overheating.

Opening the appliance door

If you open the appliance door during an operation, the operation is paused. The operation continues to run when you close the door.

Note: For some types of heating, the operation continues to run even when the appliance door is open.

Interior lighting

If you open the appliance door, the interior lighting switches on. If the door remains open for longer than around 15 minutes, the lighting switches off again.

For most operating modes, the interior lighting switches on as soon as the operation is started. When the operation has finished, the lighting switches off.

Note: You can set the interior lighting not to come on during the operation in the basic settings. → "Basic settings" on page 16

Cooling fan

The cooling fan switches on and off as required. The hot air escapes above the door.

Caution!

Do not cover the ventilation slots. Otherwise, the appliance may overheat.

So that the cooking compartment cools down more quickly after the operation, the cooling fan continues to run for a certain period afterwards.



Note: You can change how long the cooling fan continues to run for in the basic settings. → "Basic settings" on page 16

Accessories

Your appliance is accompanied by a range of accessories. Here, you can find an overview of the accessories included and information on how to use them correctly.

Accessories included

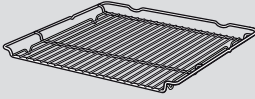
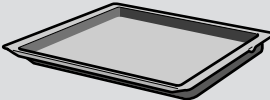
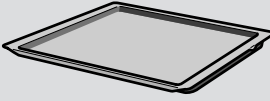
Your appliance is equipped with the following accessories:

| | |
|--|--|
|  | <p>Wire rack For ovenware, cake tins and ovenproof dishes. For roasts, grilled items and frozen meals.</p> |
|  | <p>Universal pan For moist cakes, pastries, frozen meals and large roasts. It can be used to catch dripping fat when you are grilling directly on the wire rack.</p> |
|  | <p>Baking tray For tray bakes and small baked products.</p> |
|  | <p>Accessory supports You can use these if you wish to leave an accessory (e.g. the universal pan) in the cooking compartment for cleaning by the self-cleaning function.</p> |

Only use genuine accessories. They are specially adapted for your appliance.

You can buy accessories from the after-sales service, from specialist retailers or online.

Note: The accessories may become deformed when they become hot. This does not affect their function. Once they cool down again, they regain their original shape.

Inserting accessories

The cooking compartment has four shelf positions. The shelf positions are counted from the bottom up.

In some appliances, the top shelf position in the cooking compartment features a grill symbol.

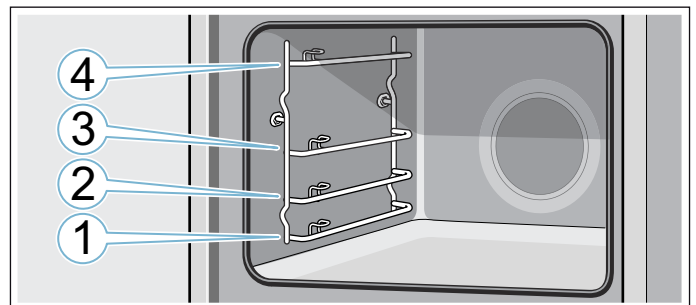

The accessories can be pulled out up to approximately halfway without tipping.

Notes

- Ensure that you always insert the accessories into the cooking compartment the right way round.
- Always insert the accessories fully into the cooking compartment so they do not touch the appliance door.

Locking function

The accessories can be pulled out approximately halfway until they lock in place. The locking function prevents the accessories from tilting when they are pulled out. The accessories must be inserted into the cooking compartment correctly for the tilt protection to work properly.

When inserting the wire rack, ensure that the lug **a** is at the rear and is facing downwards. The open side must be facing the appliance door and the curvature must be facing downwards .

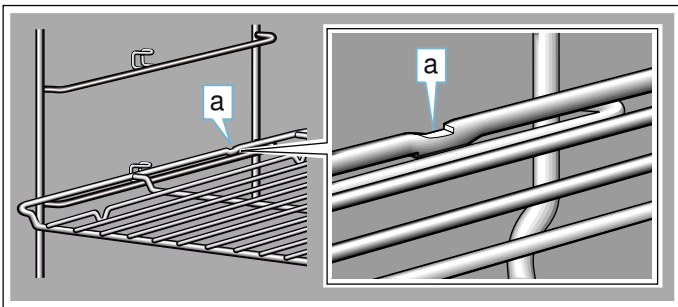

When inserting the baking tray or the universal pan, ensure that the lug **b** is at the rear and is facing downwards. The sloping edge of the accessory **c** must be facing towards the appliance door.

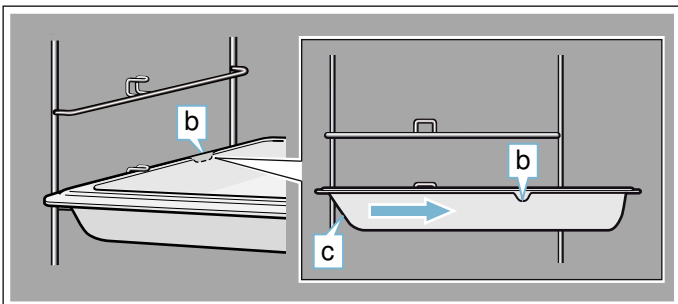

Combining accessories

You can insert the wire rack and the universal pan at the same time to catch drops of liquid.

When inserting the wire rack, ensure that both spacers **a** are at the rear edge. When the universal pan is inserted, the wire rack is on top of the upper guide rod of the shelf position.

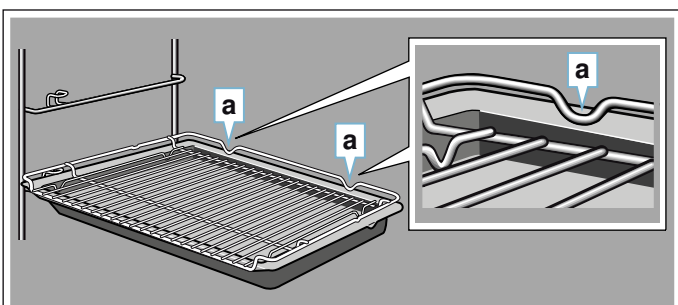

Optional accessories

You can purchase optional accessories from the after-sales service and specialist retailers, or on the Internet. You will find a comprehensive range of products for your appliance in our brochures and on the Internet.

Both availability and whether it is possible to order online differ between countries. Please see your sales documents for more details.

Note: Not all optional accessories are suitable for every appliance. When purchasing, please always quote the exact designation (E no.) of your appliance.

→ "Customer service" on page 26

Accessories

| |
|---|
| Baking and roasting shelf |
| Baking tray, suitable for pyrolytic cleaning |
| Universal pan, suitable for pyrolytic cleaning |
| Extra-deep pan, suitable for pyrolytic cleaning |
| Steaming set for ovens |
| Profi pan, suitable for pyrolytic cleaning |
| Lid for the Profi pan |
| Pizza tray |
| Grill tray, suitable for pyrolytic cleaning |
| Bread-baking stone, suitable for pyrolytic cleaning |
| Glass roasting dish, 5.1 litres |
| Glass pan |
| ComfortFlex shelf (1 level) + frame* |
| ComfortFlex rail (1 level)* |
| 3 x fully extendable pull-out rack* |

*Accessory does not fit in every appliance, quote the E no. when ordering



Before using for the first time

Before you can use your new appliance, you must make some settings. You must also clean the cooking compartment and accessories.

Initial use

As soon as the appliance is connected to the power supply, the first setting "Language" appears on the display.

Setting the language

1. Use the \vee button to navigate to the bottom line.
2. Use the \langle or \rangle button to select the language.
3. Use the \wedge button to return to "Language".
4. Use the \rangle button to select the next setting.

Setting the time

1. Use the \vee button to navigate to the next line.
2. Use the \langle or \rangle button to select the current time.
3. Press the \wedge button.
4. Use the \rangle button to select the next setting.

Setting the date

1. Use the \vee button to navigate to the next line.
2. Use the \langle or \rangle button to select the current day.
3. Use the \wedge button to return to "Day".
4. Use the \rangle button to select the next setting.
5. Use the \vee button to navigate to the next line.
6. Use the \langle or \rangle button to select the current month.
7. Use the \wedge button to return to "Month".
8. Use the \rangle button to select the next setting.
9. Use the \vee button to navigate to the next line.
10. Use the \langle or \rangle button to select the current year.
11. Use the \wedge button to return to "Year".
12. Use the \rangle button to apply the settings.

The initial use is complete.

Notes

- You can change these settings at any time in the basic settings. → "Basic settings" on page 16
- After connecting the appliance to the power or following a power cut, the settings for initial use are shown in the display.

Cleaning the cooking compartment

To remove the new-appliance smell, heat up the cooking compartment when it is empty and with the oven door closed.

1. Remove the accessories from the cooking compartment.
2. Remove leftover packaging, such as polystyrene pellets, from the cooking compartment.
3. Before heating the appliance, wipe the smooth surfaces in the cooking compartment with a soft, wet cloth.
4. Use the $\textcircled{1}$ touch button to switch on the appliance.
5. Set the heating type and temperature, then start the appliance operation. → "Setting and starting the appliance operation" on page 13

Settings

| | |
|--------------|-----------------------------|
| Heating type | Top/bottom heating \equiv |
| Temperature | 240 °C |
| Cooking time | 1 hour |

6. Keep the kitchen ventilated while the appliance is heating up.
7. Use the $\textcircled{1}$ touch button to switch off the appliance after the indicated cooking time.
8. Wait until the cooking compartment has cooled down.
9. Clean the smooth surfaces with soapy water and a dish cloth.

Cleaning the accessories

Clean the accessories thoroughly using soapy water and a dish cloth or soft brush.

Operating the appliance

You have already learnt about the controls and how they work. Now we will explain how to set your appliance. You will learn about what happens when you switch the appliance on and off, and how to select the operating mode.

Switching the appliance on and off

Touch the  touch button to switch the appliance on or off.

After switching off the appliance, on the display you can see if the residual heat in the cooking compartment is high or low.



| Display | Meaning |
|---------|--|
| -H- | Residual heat high (above 120 °C) |
| -h- | Residual heat low (between 60 °C and 120 °C) |

Notes





- Certain displays and notes, such as the residual heat in the cooking compartment, remain visible on the display even when the appliance is switched off.
- After an appliance operation, the cooling fan runs on audibly until the cooking compartment has been cooled as far as possible.
- Switch off your device when you do not need to use it. If no settings are applied for a long time, the appliance switches itself off automatically.

Setting and starting the appliance operation

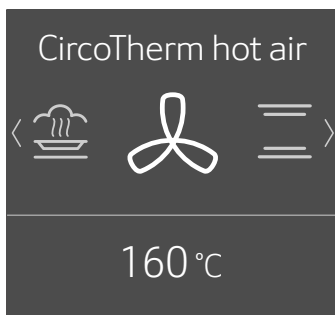

Example: CircoTherm hot air  at 170 °C

1. Touch the  touch button to switch on the appliance.
You are taken directly to the  menu for the types of heating.

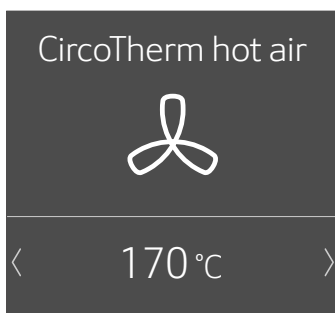

2. Use the  or  button to select the type of heating.
3. Use the  button to navigate to the next line.
4. Use the  or  button to select the temperature.



Note: Depending on the operating mode, different settings are available. For each further setting, use the  button to navigate to the next line. Use the  or  button to select the setting.

5. Touch the  touch button to start the appliance operation.
The heating bar and run time appear on the display.

Note: If you would like to go directly to the  main menu after switching on the appliance, you can select the main menu under "Operation after switching on" in the basic settings chapter. → "Basic settings" on page 16

Default values

The appliance suggests a temperature or setting for each type of heating. You can accept this value or change it in the appropriate area.

Heating bar

As soon as a type of heating has started, the heating bar appears on the display. The heating bar shows the temperature increase in the cooking compartment.

Run time



When a type of heating has been started, the run time is displayed. The run time counts upwards during the operation. You can therefore check how long the operation has already been running.

Displaying the current temperature

To show the current temperature on the display, press the  touch button.







The current temperature is shown briefly only when heating up.

Further information

If the  touch button lights up, information can be displayed. Touch the  touch button to do this. The information is displayed for a few seconds.

Changing or cancelling the appliance operation

Changing the appliance operation

1. Use the  button to stop the operation.
2. Use the  or  button to navigate to the line for the setting that should be changed.
3. Use the  or  button to change the setting.
4. Use the  touch button to start the changed operation.

Notes

- The cooling fan may continue to run while an operation is interrupted.
- After a temperature change, the paused running time continues to count. After a change in the type of heating, the running time starts again from zero.



Cancelling the appliance operation

Press and hold the  touch button until the appliance operation is cancelled.

Note: Operating modes such as the cleaning function cannot be cancelled.



Heating up the appliance quickly

You can use the "Rapid heat-up" and "PowerBoost" functions to reduce the preheat time. Whether the appliance is preheated with the "Rapid heat-up" function or the "PowerBoost" function depends on the type of heating that has been set. With the "PowerBoost" function, unlike with the "Rapid heat-up" function, you can place your food into the cold cooking compartment even before preheating has begun. Only cook on one level when using the "PowerBoost" function.





| Function | Type of heating | Place the food in the cooking compartment |
|---------------|--|---|
| Rapid heat-up | Top/bottom heating  | after preheating |
| PowerBoost* | CircoTherm hot air  Bread-baking setting  | before preheating |

* Do not use more than one level for cooking







Notes

- If the  touch button is lit, the "Rapid heat-up" or "PowerBoost" function can be activated.
- To deactivate the "Rapid heat-up" or "PowerBoost" function before it has finished, touch the  touch button.

Activating the "Rapid heat-up" function



1. Set top/bottom heating  and the temperature.
Note: Set a temperature above 100 °C to allow the appliance to preheat quickly.
2. Touch the  touch button to start the appliance operation.
3. Touch the  touch button to activate the "Rapid heat-up" function.
The  symbol appears on the display.
4. Once the set temperature has been reached, the "Rapid heat-up" function switches itself off automatically. The  symbol disappears from the display. Place the food in the cooking compartment

Activating the "PowerBoost" function

1. Set CircoTherm hot air  or the bread baking setting  and the temperature.
Note: Set a temperature above 100 °C to allow the appliance to preheat quickly.
2. Place the food on a single level in the cooking compartment.
3. Touch the  touch button to start the appliance operation.
4. Touch the  touch button to activate the "PowerBoost" function.
The  symbol appears on the display.
Once the set temperature has been reached, the "PowerBoost" function switches itself off automatically. The  symbol disappears from the display.

Time-setting options

Your appliance has different time-setting options.

| Time-setting option | Use |
|--|--|
|  Timer | The timer functions like an egg timer. The appliance does not switch on and off automatically. |
|  Cooking time | Once the set cooking time has elapsed, the appliance switches off automatically. |
|  Ready at | The appliance switches on automatically, and once the set cooking time has elapsed and the end time has passed, it switches off automatically. |

Note: If you have set a time-setting option, the time interval increases if you set a higher value. Example: You can set a cooking time of up to one hour in one-minute increments; for cooking times over one hour, you can set a cooking time in five-minute increments.

Showing and hiding the time-setting options





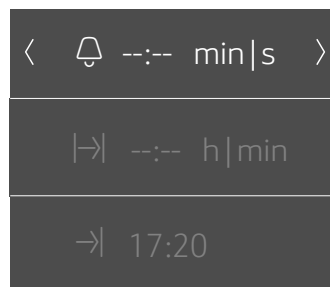

To show or hide the time-setting options, touch the  touch button.

Note: After a particular length of time, the time-setting options that are shown are automatically hidden. If you have already set a cooking time, it will be applied.



Setting the timer







The timer can be set when the appliance is switched on or off.

1. Touch the  touch button.
The time-setting options are shown on the display.
2. Select the cooking time using the  button.
Note: When the appliance is switched on, use the  button to navigate to the Timer  line and then select the cooking time using the  button.
3. Touch the  touch button to start the timer.
The  symbol appears on the display. The timer counts down.

Note: As soon as the set time has elapsed, a signal sounds. To cancel the signal tone, touch the  touch button.

Setting the cooking time

Once the set cooking time has elapsed, the appliance switches off automatically. The function can only be used in combination with a type of heating.

1. Touch the  touch button.
2. Set the type of heating and temperature.
3. Touch the  touch button.
The time-setting options are shown in the display.
4. Use the  or  button to set the cooking time.
 - Default value for the  button = 10 minutes
 - Default value for the  button = 30 minutes
5. Touch the  touch button to start the set cooking time.







As soon as the cooking time has elapsed, an audible signal sounds and the appliance ends the operation automatically. Touch the  touch button to end the audible signal.

Start delay – "Ready at"

The appliance switches on automatically and switches off at the preset end time. To do this, set the cooking time and determine the end time for the operation.





The start delay can only be used in combination with a type of heating.

Notes

- Ensure that food is not left in the cooking compartment for too long as it may spoil.
 - It is not possible to start every type of heating with a start delay.
1. Slide food into the cooking compartment on a suitable accessory and close the appliance door.
 2. Touch the  touch button.
 3. Set the type of heating and temperature.
 4. Touch the  touch button.
The time-setting options are shown on the display.
 5. Select the cooking time using the  button.
 6. Use the  button to navigate to the "→ Ready at" line.
 7. Select the end time using the  button.
 8. Touch the  touch button.
The appliance waits until the appropriate time to start the operation.

As soon as the end time has passed, a signal sounds and the appliance stops the operation automatically. To cancel the signal tone, touch the  touch button.

Checking, changing or deleting settings



1. Touch the  touch button.
The time-setting options are shown on the display.
2. Use the  or  button to navigate through the lines.
3. If necessary, change the setting using the  or  button. Set "00:00" to delete a time function.
The setting is applied automatically.

Childproof lock

Your appliance is equipped with a childproof lock so that children cannot switch it on accidentally or change any settings.

Your appliance has two different locks.













| Lock | Activate/deactivate |
|---------------------------|--|
| Automatic childproof lock | Via the Settings menu → "Basic settings" on page 16 |
| One-time childproof lock | Via the  touch button |

Note: As soon as you activate the childproof lock, the control panel is locked. The  and  touch buttons are not included. You can deactivate the childproof lock at any time.



Automatic childproof lock

The control panel is locked so that the appliance cannot be switched on. To switch it on, the automatic childproof lock must be interrupted. After the appliance operation, the control panel is locked automatically.















Activating

1. Touch the  touch button.
2. Touch the  touch button.
3. Use the  or  button to select the "Settings".
4. Use the  button to navigate to the next line.
5. Use the  or  button to select "Automatic childproof lock".
6. Use the  button to navigate to the next line.
7. Use the  or  button to select "Activated".
8. Touch the  touch button.
9. Use the  button to navigate to the next line to save the setting.
The "Automatic childproof lock" is activated. The  symbol appears on the display after switching off the appliance.

Cancelling

1. Press and hold the  touch button until "Childproof lock deactivated" appears on the display.
2. Touch the  touch button.
3. Switch on the required appliance operation.

Deactivating

1. Press and hold the  touch button until "Childproof lock deactivated" appears on the display.
2. Touch the  touch button.
3. Touch the  touch button.
4. Use the  or  button to select the "Settings".
5. Use the  button to navigate to the next line.
6. Use the  or  button to select "Automatic childproof lock".
7. Use the  button to navigate to the next line.
8. Use the  or  button to select "Deactivated".
9. Touch the  touch button.
10. Use the  button to navigate to the next line to save the setting.
The "Automatic childproof lock" is deactivated.
11. Touch the  touch button.

One-time childproof lock

The control panel is locked so that the appliance cannot be switched on. To switch it on, the one-time childproof lock must be deactivated. After the appliance is switched off, the control panel is no longer locked.

Activating and deactivating

1. Press and hold the ⊖ touch button until "Childproof lock activated" appears on the display.
The childproof lock is activated.
2. Press and hold the ⊖ touch button until "Childproof lock deactivated" appears on the display.
The childproof lock is deactivated.

Basic settings

There are various settings available to you in order to help use your appliance effectively and simply. You can change these settings as required.

Changing the basic settings

1. Touch the ⊕ touch button.
2. Touch the ⬆ touch button.
3. Use the < or > button to select the "⚙ Settings".
4. Use the ~ button to navigate to the next line.
5. Use the < or > button to select the setting.
6. Use the ~ button to navigate to the next line.
7. Use the < or > button to select the setting.
8. Touch the ⬆ touch button.
9. To save the setting, use the ~ button to select "Save".
To discard the setting, use the ^ button to select "Discard".

List of basic settings

















| Setting | Selection |
|---------------------------|---|
| Language | Select language |
| Time of day | Sets the current time |
| Date | Sets the current date |
| Favourites | Set the heating types that should be shown in the heating types menu → "Setting favourites" on page 17 |
| Audible signal duration | Short |
| | Medium |
| | Long |
| Button tone | Switched off (Exception: The button tone for the ⊕ touch button remains switched on) |
| | Switched on |
| Display brightness | Adjustable across 5 levels |
| Clock display | Digital |
| | Off |
| Lighting | On during operation |
| | Off during operation |
| Childproof lock* | Only key lock |
| | Door lock and key lock |
| Automatic childproof lock | Deactivated |
| | Activated |
| Action after switching on | Main menu |
| | Heating types |
| Night-time dimming | Switched off |
| | Switched on (display dimmed between 10 p.m. and 5.59 a.m.) |
| Brand name logo | Display |
| | Do not display |

| | |
|--|---|
| Fan run-on time | Recommended Minimum |
| Pull-out system | No Yes (double or triple pull-out system retro-fitted) |
| Factory settings | Load |
| *) Depending on the appliance model, this basic setting cannot be selected | |

Setting favourites

You can set which heating types are shown in the Types of heating menu.

Note: The "CircoTherm hot air", "Circo-roasting" and "Grill, large area" types of heating are always shown in the Types of heating menu. They cannot be deactivated.

1. Touch the  touch button.
2. Touch the  touch button.
3. Use the  or  button to select the "Settings".
4. Use the  button to navigate to the next line.
5. Use the  or  button to select "Favourites".
6. Use the  button to navigate to the next line.
7. Use the  or  button to select the type of heating.
8. Use the  button to navigate to the next line.
9. Use the  or  button to select "Activated" or "Deactivated".
Note: If you have selected "Activated", the type of heating is shown in the Types of heating menu. If you have selected "Deactivated", the type of heating is shown in the Types of heating menu.
10. Touch the  touch button.
11. To save the setting, use the  button to select "Save".
To discard the setting, use the  button to select "Discard".

Sabbath mode











You can set a time of up to 74 hours using Sabbath mode. The food in the cooking compartment remains warm, without you having to switch the appliance on or off.

Starting Sabbath mode

Before you can use Sabbath mode, you must activate it under "Favourites" in the basic settings. → "Setting favourites" on page 17

Once the Sabbath mode has been activated, you can select it under the menu for the types of heating.

The appliance heats up with top/bottom heating. The temperature can be set between 85 °C and 140 °C.

1. Touch the  touch button.
2. Use the  or  button to select "Sabbath mode".
3. Use the  button to navigate to the next line.
4. Use the  or  button to select the temperature.
5. Use the  button to navigate to the next line.
6. Use the  or  button to select the cooking time.
7. Touch the  touch button.
The appliance starts the operation.

Notes

- Once Sabbath mode has started, you can no longer change any settings or cancel the operation using the  touch button.
- The operation is not interrupted if you open the appliance door.

Once the Sabbath mode duration has elapsed, a signal sounds. The appliance stops heating. Use the  touch button to switch off the appliance.

Cancelling Sabbath mode

Touch the  touch button to cancel Sabbath mode.

Cleaning agent

With good care and cleaning, your appliance will retain its appearance and remain fully functioning for a long time to come. We will explain here how you should correctly care for and clean your appliance.

Suitable cleaning agents

To ensure that the different surfaces are not damaged by using the wrong cleaning agent, observe the information in the table. Depending on the appliance model, not all of the areas listed may be on/in your appliance.

Caution!

Risk of surface damage

Do not use:

- Harsh or abrasive cleaning agents,
- Cleaning agents with a high alcohol content,
- Hard scouring pads or cleaning sponges,
- High-pressure cleaners or steam cleaners,
- Special cleaners for cleaning the appliance while it is hot.

Wash new sponge cloths thoroughly before use.

Tip: Highly recommended cleaning and care products can be purchased through the after-sales service. Observe the respective manufacturer's instructions.

Warning – Risk of burns!

The appliance becomes very hot. Never touch the interior surfaces of the cooking compartment or the heating elements. Always allow the appliance to cool down. Keep children at a safe distance.

| Area | Cleaning |
|---------------------------|--|
| Appliance exterior | |
| Stainless steel front | Hot soapy water: Clean with a dish cloth and then dry with a soft cloth. Remove flecks of limescale, grease, starch and albumin (e.g. egg white) immediately. Corrosion can form under such flecks. Special stainless steel cleaning products suitable for hot surfaces are available from our after-sales service or from specialist retailers. Apply a very thin layer of the cleaning product with a soft cloth. |
| Plastic | Hot soapy water: Clean with a dish cloth and then dry with a soft cloth. Do not use glass cleaner or a glass scraper. |
| Painted surfaces | Hot soapy water: Clean with a dish cloth and then dry with a soft cloth. |
| Control panel | Hot soapy water: Clean with a dish cloth and then dry with a soft cloth. Do not use glass cleaner or a glass scraper. |

| | |
|---------------------------------------|--|
| Door panels | Hot soapy water: Clean with a dish cloth and then dry with a soft cloth. Do not use a glass scraper or a stainless steel scouring pad. |
| Door handle | Hot soapy water: Clean with a dish cloth and then dry with a soft cloth. If descaler comes into contact with the door handle, wipe it off immediately. Otherwise, any stains will not be able to be removed. |
| Appliance interior | |
| Enamelled surfaces | Hot soapy water or a vinegar solution: Clean with a dish cloth and then dry with a soft cloth. Soften baked-on food remnants with a damp cloth and soapy water. Use stainless steel wire wool or oven cleaner to remove stubborn dirt. Caution! Never use oven cleaner in the cooking compartment when it is still warm. This may damage the enamel. Remove all food remnants from the cooking compartment and the appliance door before you next heat up the appliance. Leave the cooking compartment open to dry after cleaning it. It is best to use the cleaning function. → "Cleaning function" on page 19 Note: Food residues can cause white deposits to form. These are harmless and do not affect how the appliance works. Remove using lemon juice if required. |
| Glass cover for the interior lighting | Hot soapy water: Clean with a dish cloth and then dry with a soft cloth. If the cooking compartment is heavily soiled, use oven cleaner. |
| Door cover | made from stainless steel: Use stainless steel cleaner. Follow the manufacturers' instructions. Do not use stainless steel care products. made from plastic: Clean using hot soapy water and a dish cloth. Dry with a soft cloth. Do not use glass cleaner or a glass scraper. Remove the door cover for cleaning. |
| Rails | Hot soapy water: Soak and clean with a dish cloth or brush. |
| Pull-out system | Hot soapy water: Clean with a dish cloth or a brush. Do not remove the lubricant while the pull-out rails are pulled out – it is best to clean them when they are pushed in. Do not clean in the dishwasher. |
| Accessories | Hot soapy water: Soak and clean with a dish cloth or brush. If there are heavy deposits of dirt, use a stainless steel scouring pad. |

Notes

- Slight differences in colour on the front of the appliance are caused by the use of different materials, such as glass, plastic and metal.
- Shadows on the door panels, which look like streaks, are caused by reflections made by the interior lighting.
- Enamel is baked on at very high temperatures. This can cause some slight colour variation. This is normal and does not affect operation. The edges of thin trays cannot be completely enamelled. As a result, these edges can be rough. This does not impair the anti-corrosion protection.

Keeping the appliance clean

Always keep the appliance clean and remove dirt immediately so that stubborn deposits of dirt do not build up.

Warning – Risk of fire!

Loose food remnants, fat and meat juices may catch fire. Before using the appliance, remove the worst of the food remnants from the cooking compartment, heating elements and accessories.

Tips

- Clean the cooking compartment after each use. This will ensure that dirt cannot be baked on.
- Always remove flecks of limescale, grease, starch and albumin (e.g. egg white) immediately.
- Use the universal pan for baking very moist cakes.
- Use suitable ovenware for roasting, e.g. a roasting dish.

Cleaning function

Your appliance is equipped with a self-cleaning function and EasyClean. You can use the self-cleaning function to clean the cooking compartment. Use the EasyClean cleaning aid for intermediate cleaning of the cooking compartment. Dirt is softened beforehand using EasyClean. It can then be removed more easily.

Self-cleaning

Use "Self-cleaning" mode to clean the cooking compartment.

You can choose from three cleaning settings.

| Setting | Cleaning level | Duration |
|---------|----------------|----------------------------|
| 1 | Light | Approx. 1 hour, 15 minutes |
| 2 | Medium | Approx. 1 hour, 30 minutes |
| 3 | Intensive | Approx. 2 hours |

The dirtier the cooking compartment and the longer the dirt has been there, the higher the cleaning setting should be. A cleaning cycle requires only approx. 2.5 – 4.7 kilowatt hours.

Note: For your safety, the cooking compartment door locks automatically. It cannot be opened again until the  symbol for the locking mechanism goes out in the status bar. The interior lighting remains off during cleaning.

Warning

Risk of burns!

- The cooking compartment becomes extremely hot during the cleaning function. Never open the appliance door. Allow the appliance to cool down. Keep children away from the appliance.
-  The appliance will become very hot on the outside during the cleaning function. Never touch the appliance door. Allow the appliance to cool down. Keep children away from the appliance.

Warning

Risk of harm to health!

The cleaning function heats up the cooking compartment to a very high temperature so that food remnants left over from roasting, grilling and baking will burn off. This process releases vapours, which can irritate the mucous membranes. While the cleaning function is running, keep the kitchen well ventilated. Do not remain in the room for long periods. Keep children and pets away. Follow the instructions even when using the Delayed start function with a delayed end time.

Preparation

⚠ Warning

Risk of fire!

- Loose food residues, grease and meat juices may catch fire during the cleaning function. Before starting the cleaning function, remove coarse dirt from the cooking compartment and from the accessories.
- The appliance will become very hot on the outside during the cleaning function. Never hang combustible objects, e.g. tea towels, on the door handle. Do not place anything against the front of the appliance. Keep children away from the appliance.

⚠ Warning – Risk of serious damage to health!

The appliance will become very hot during the cleaning function. The non-stick coating on baking trays and tins is destroyed and noxious gases are released. Never clean non-stick baking trays and baking tins using the cleaning function. Only clean enamelled accessories using the cleaning function.

Caution!

Shelf supports and pull-out rails tend to discolour if they are left in the cooking compartment when it is cleaned. Before you start the cleaning function, remove the shelf supports and pull-out rails from the cooking compartment.

- Remove the shelf supports and pull-out rails from the cooking compartment. → "Rails" on page 22
- Remove the worst of the food residues from the cooking compartment and accessories.
- Clean the inside of the appliance door and along the edges of the cooking compartment in the area around the seal. Do not scrub the seal. → "Cleaning agent" on page 18
- Insert the accessory supports if you wish to clean accessories when the cooking compartment is being cleaned. Make sure that the vertical bar **a** on the accessory support is facing the front (figure **1**).

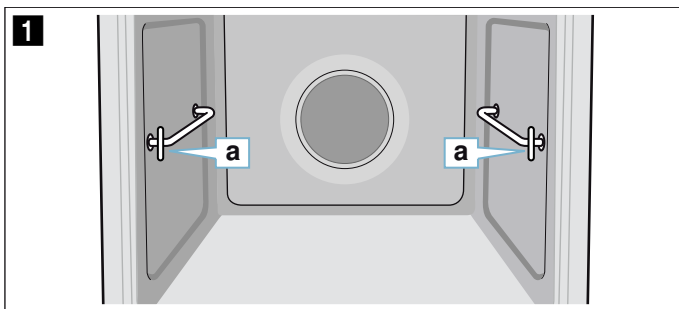

- Insert the rear end of the accessory support as far as it will go into the rear socket **b**, and push the accessory support back **c** (figure **2**).

- Then insert the front end of the accessory support as far as it will go into the front socket **d**, and push the accessory support down **e** (figure **3**).

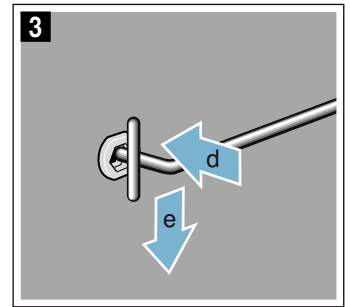
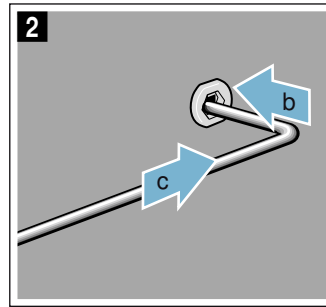

- Whenever you wish to use the cleaning function, make sure that you never leave anything other than an enamelled accessory without anti-stick coating (e.g. the universal pan) on the accessory supports (figure **4**).

Caution!

The wire rack tends to discolour if it is left in the cooking compartment when it is cleaned. Do not attempt to clean the rack using the cleaning function.

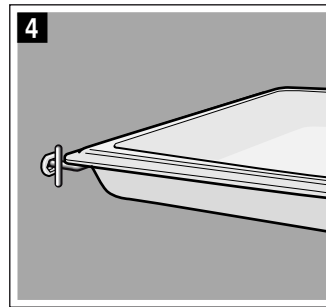

Note: Further accessories that can be cleaned using the cleaning function are listed in the table for special accessories. → "Accessories" on page 10

Starting

- Touch the **1** touch button.
- Touch the **⏏** touch button.
- Use the **<** or **>** button to select "Self-cleaning **🌀**".
- Use the **⏏** button to navigate to the next line.
- Use the **<** or **>** button to select the cleaning setting.
Note: Once it has started, the cleaning setting can no longer be changed.
- Use the **⏏** button to navigate to the next line.
- Touch the **▶||** touch button.
The appliance starts self-cleaning.

Ventilate the kitchen when the cleaning function is running.

During self-cleaning, the appliance door is locked automatically. The **🔒** symbol appears on the display.

Note: If you would like to start self-cleaning later, set an end time.

Cancelling

Touch the **1** touch button to cancel. The appliance door cannot be opened until the **🔒** symbol goes out.

Finishing

As soon as self-cleaning has run through, a signal sounds. The appliance door cannot be opened until the  symbol goes out.

Once the cleaning function has ended

1. Allow the cooking compartment to cool down.
2. Wipe off any ash that has been left behind in the cooking compartment and around the appliance door with a damp cloth.
3. If you have left an accessory inside the cooking compartment to be cleaned, remove it and wipe it down with a damp cloth.
4. Lift the accessory support up at the front and remove it. → "Rails" on page 22
5. Refit the shelf supports or pull-out rails. → "Rails" on page 22

EasyClean



The EasyClean cleaning aid makes it easier to clean the cooking compartment. Dirt is softened beforehand by vaporizing soapy water. It can then be removed more easily.







Warning – Risk of scalding!

Water in a hot cooking compartment may create hot steam. Never pour water into the hot cooking compartment.

Starting

Notes

- The "EasyClean " cleaning aid can only be started once the cooking compartment is cold (room temperature) and the appliance door is closed.
- Do not open the appliance door during operation. Doing this will interrupt the "EasyClean " cleaning aid.

1. Remove the accessories from the cooking compartment.
2. Mix 0.4 litres of water (not distilled water) with a drop of washing-up liquid and pour into the middle of the cooking compartment floor.
3. Touch the  touch button.
4. Touch the  touch button.
5. Use the  or  button to select "EasyClean ".
6. Use the  button to navigate to the next line.
7. Touch the  touch button.
The appliance starts EasyClean. The remaining time appears on the display.

Finishing

As soon as the cleaning aid has finished, an audible signal sounds and the appliance ends the operation automatically.

As soon as you open the appliance door, the interior lighting is switched on so that you can finish cleaning the cooking compartment more easily. The remaining water in the cooking compartment must be removed promptly. Do not leave the remaining water in the cooking compartment for a long time (e.g. overnight). The appliance must not be operated when the cooking compartment is still wet or damp.

Final cleaning

1. Open the appliance door and remove the remaining water with an absorbent sponge cloth.
2. Clean the smooth surfaces in the cooking compartment with a dish cloth or a soft brush. Stubborn residues can be removed using a stainless steel scouring pad.
3. Remove limescale with a cloth soaked in vinegar. Then wipe with clean water and rub dry with a soft cloth (including under the door seal).
4. Use the  touch button to switch off the appliance.
5. Leave the appliance door ajar in the locking position (approx. 30°) for approx. 1 hour to allow the enamel surfaces in the cooking compartment to dry. Alternatively, you can also run the rapid drying function for the cooking compartment.

Running the rapid drying function for the cooking compartment

1. After the cleaning aid process has finished, leave the appliance door ajar in the locking position (approx. 30°).
2. Touch the  touch button.
3. Start CircoTherm hot air at 50 °C.
4. After 5 minutes, switch off the appliance and close the appliance door.

Removing heavy deposits of dirt

You have several options for removing particularly stubborn deposits of dirt.

- Leave the soapy water to work for some time before starting the cleaning aid.
- Rub soapy water onto the dirt on the smooth surfaces before starting the cleaning aid.
- Repeat the cleaning aid once the cooking compartment has cooled down.

Rails

With good care and cleaning, your appliance will retain its appearance and remain fully functional for a long time to come. This will tell you how to remove the shelves and clean them.

Detaching and refitting the rails

Warning – Risk of burns!

The rails become very hot. Never touch the hot rails. Always allow the appliance to cool down. Keep children away from the appliance.

Detaching the rails

1. Lift the rail slightly at the front **a** and detach it **b** (figure **1**).
2. Then pull the whole rail towards you and take it out (figure **2**).

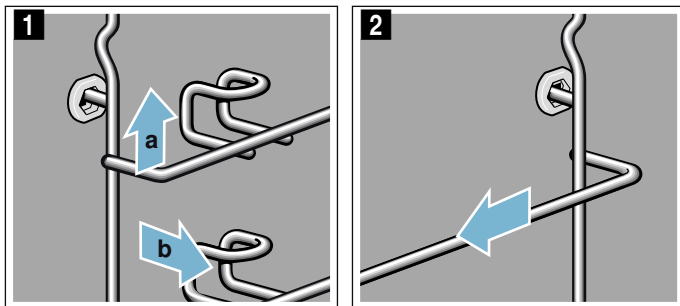

Clean the rails with cleaning agent and a sponge. For stubborn deposits of dirt, use a brush.

Attaching the rails

The rails only fit on the right or the left side. For both rails, ensure that the retaining bracket is at the front.

1. First, insert the rail in the middle of the rear socket **a**, until the rail rests against the cooking compartment wall, and push it back **b** (figure **1**).
2. Then insert the rail into the front socket **c**, until the rail also rests against the cooking compartment wall here, and press it downwards **d** (figure **2**).

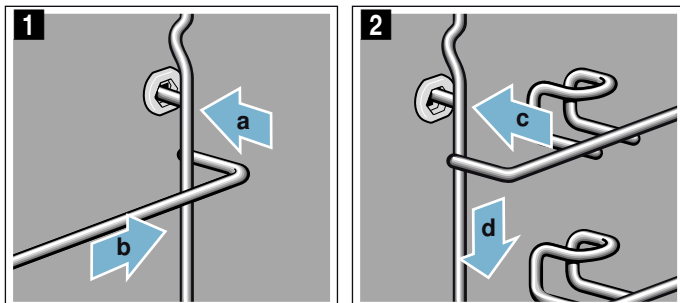

Appliance door

With good care and cleaning, your appliance will retain its appearance and remain fully functional for a long time to come. This will tell you how to remove the appliance door and clean it.

Removing and fitting the appliance door

For cleaning purposes and to remove the door panels, you can detach the appliance door.

The appliance door hinges each have a locking lever. When the locking levers are closed (figure **1**), the appliance door is secured in place. It cannot be detached.

When the locking levers are open in order to detach the appliance door (figure **2**), the hinges are locked. They cannot snap shut.

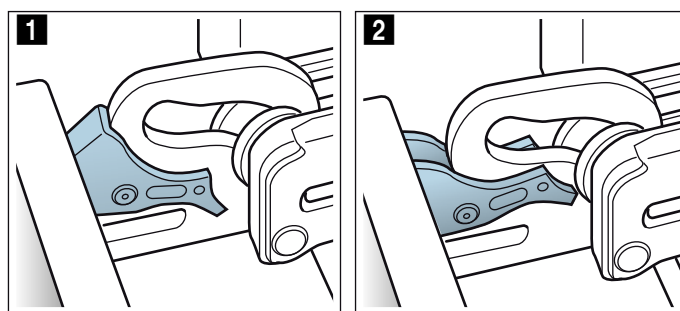

Warning **Risk of injury!**

- If the hinges are not locked, they can snap shut with great force. Ensure that the locking levers are always fully closed or, when detaching the appliance door, fully open.
- The hinges on the appliance door move when opening and closing the door, and you may be trapped. Keep your hands away from the hinges.

Removing the appliance door

1. Open the appliance door fully and push it in the direction of the appliance.
2. Fold up the two locking levers on the left and right (figure **1**).
3. Close the appliance door as far as it goes **a**. With both hands, grip the door on the left- and right-hand side and pull it up and out (figure **2**).

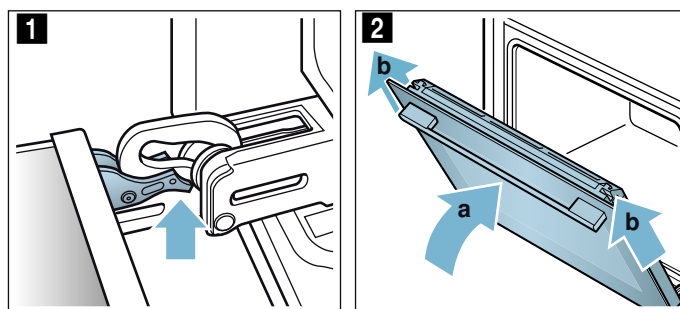

Fitting the appliance door

Reattach the appliance door in the opposite sequence to removal.

1. When attaching the appliance door, ensure that both hinges are inserted straight into the opening (figure 1). Place both hinges at the bottom on the outer panel and use this as a guide. Ensure that the hinges are inserted into the correct opening. You must be able to insert them easily and without resistance. If you can feel any resistance, check that the hinges are inserted into the correct opening.

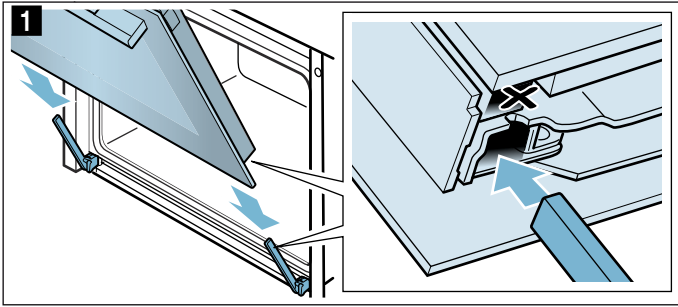

2. Open the appliance door fully. Fold both locking levers closed again (figure 2).

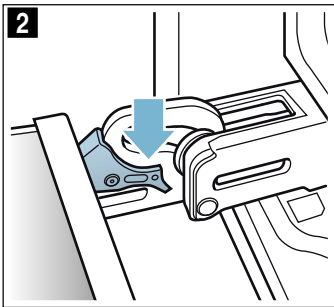

3. Close the cooking compartment door.

Removing the door cover

The stainless steel inlay in the door cover may become discoloured. To carry out thorough cleaning, you can remove the cover.

1. Open the appliance door slightly.
2. Press on the right and left side of the cover (figure 1).
3. Remove the cover (figure 2). Close the appliance door carefully.

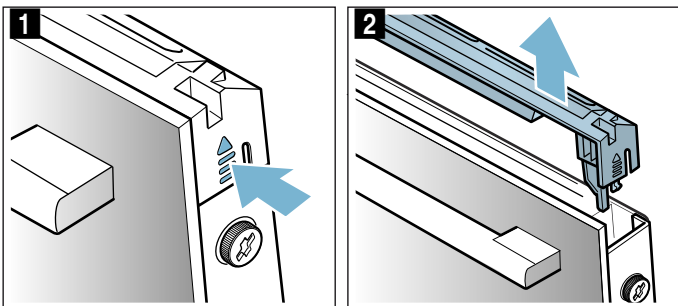

Note: Clean the stainless steel inlay in the cover with stainless steel cleaner. Clean the rest of the door cover with soapy water and a soft cloth.

4. Open the appliance door again slightly. Put the cover back in place and press on it until it clicks audibly into place (figure 3).

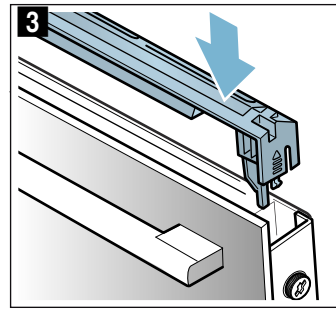

5. Close the appliance door.

Removing and installing the door panels

To facilitate cleaning, you can remove the glass panels from the appliance door.

Removing the door from the appliance

1. Open the appliance door slightly.
2. Press on the right and left side of the cover (figure 1).
3. Remove the cover (figure 2).

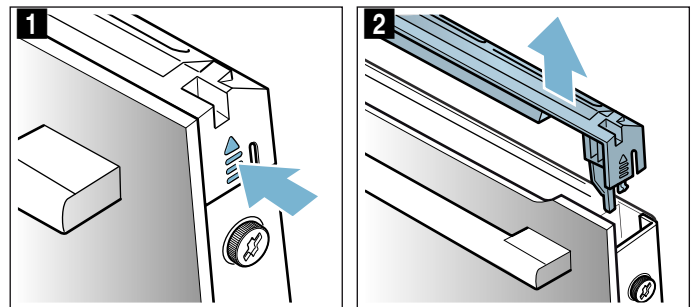

4. Loosen and remove the screws on the left and right of the appliance door (figure 3).
5. Before closing the door again, trap a tea towel which has been folded several times in the door (figure 4). Pull out the front panel upwards and lay it on a flat surface with the door handle facing downwards.

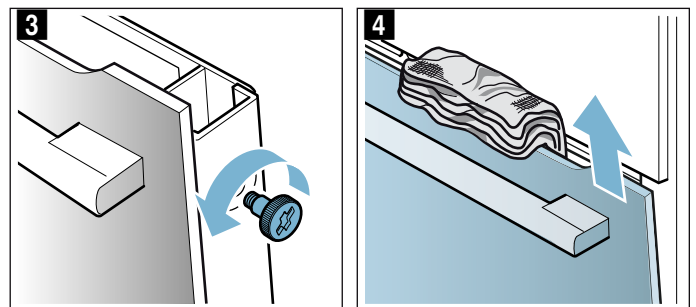

6. Push both retainers on the intermediate panel upwards, but do not remove it (figure 5). Hold the panel with one hand. Remove the panel.

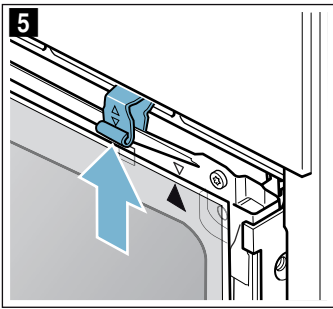

Clean the panels with glass cleaner and a soft cloth.

Warning
Risk of injury!

- Scratched glass in the appliance door may develop into a crack. Do not use a glass scraper, sharp or abrasive cleaning aids or detergents.
- The hinges on the appliance door move when opening and closing the door, and you may be trapped. Keep your hands away from the hinges.

Fitting the door on the appliance

When fitting the intermediate panel, make sure that the arrow is in the top right of the panel and that it aligns with the arrow on the metal panel.

1. Insert the intermediate panel at the bottom into the retainer and push it in firmly at the top (figure 1).
2. Push both retainers downwards (figure 2).

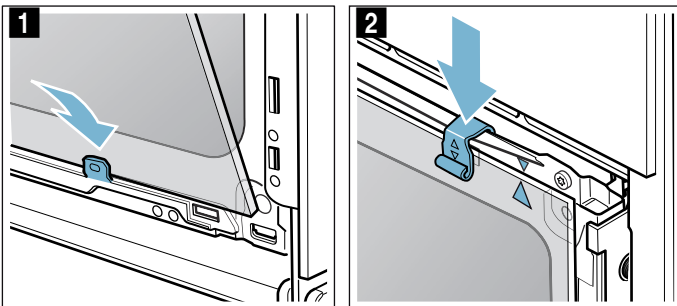

3. Insert the front panel at the bottom into the retainers (figure 3).
4. Close the front panel until both upper hooks are opposite the opening (figure 4).

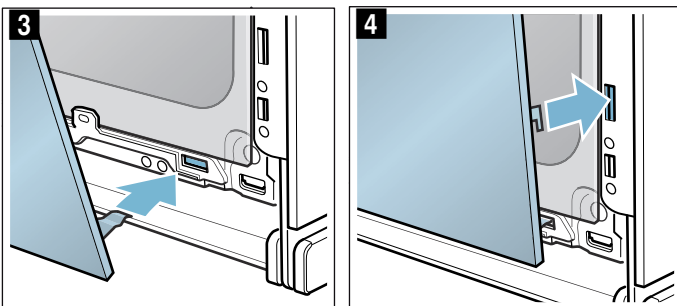

5. Press the front panel at the bottom until it clicks audibly into place (figure 5).
6. Open the appliance door again slightly and remove the tea towel.
7. Screw both screws back in on the left and right.

8. Put the cover back in place and press on it until it clicks audibly into place (figure 6).

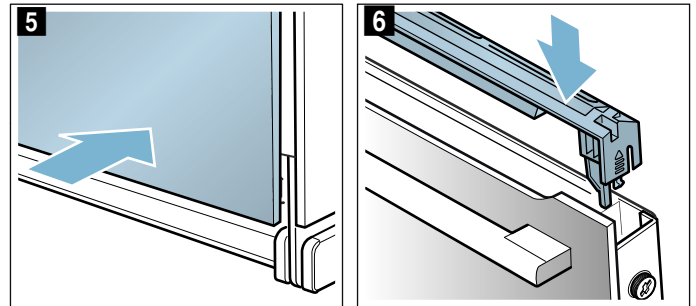

9. Close the appliance door.

Caution!

Do not use the cooking compartment again until the panels have been correctly fitted.

Trouble shooting

If a fault occurs, there is often a simple explanation. Before calling the after-sales service, please refer to the fault table and attempt to correct the fault yourself.

Tip: If a meal does not turn out exactly as you wanted, refer to the "Tested for you in our cooking studio" section. Here, you will find plenty of cooking tips and notes.











Warning – Risk of electric shock!

Incorrect repairs are dangerous. Repairs may only be carried out and damaged power cables replaced by one of our trained after-sales technicians. If the appliance is defective, unplug the appliance from the mains or switch off the circuit breaker in the fuse box. Contact the after-sales service.

Fault table

Warning – Risk of electric shock!

- Work on the appliance electronics may only be performed by a specialist.
- Always disconnect the appliance from the power supply when work is carried out on the electronics. Switch off the circuit breaker or remove the fuse from your household fuse box.

| Fault | Possible cause | Notes/remedy |
|---|--|---|
| The appliance does not work | The plug is not plugged into the mains | Connect the appliance to the power supply |
| | Power cut | Check whether other kitchen appliances are working |
| | The circuit breaker is faulty | Check in the fuse box to make sure that the fuse for the appliance is OK |
| After switching on an operating mode, a message is shown on the display which indicates that the temperature is too high | The appliance has not cooled down sufficiently | Allow the appliance to cool down and switch the operating mode on again |
| The appliance cannot be switched on; the  symbol is shown on the display | The automatic childproof lock is activated | Press and hold the  touch button until the  symbol goes out |
| The appliance cannot be operated when it is switched on; the  symbol is shown on the display | The childproof lock is activated | Press and hold the  touch button until the  symbol goes out |
| The appliance does not heat up;  is shown on the display | Demo mode is activated in the basic settings | Disconnect the appliance from the mains for approx. 10 seconds (switch off the circuit breaker in the fuse box) and then deactivate demo mode in the basic settings within 3 minutes → "Basic settings" on page 16 |
| The appliance door cannot be opened; the  symbol is shown on the display | The appliance door is locked until the cooking compartment has cooled down | Wait until the  symbol goes out |
| | The childproof lock locks the appliance door | Press and hold the  touch button until the  symbol goes out; adjust the childproof lock setting |
| "D" or "E" appears on the display, e.g. D0111 or E0111 | Technical problem | Switch the appliance off and on again If the message appears again, call the after-sales service. Quote the exact error message |

Maximum operating time exceeded

Your appliance ends the operation automatically when no cooking time is set and the setting has not been changed for a long time.

The actual cooking time until the operation is stopped automatically varies according to the selected settings.

The appliance display indicates that the operation will end automatically. Afterwards, the operation is stopped.

To use the appliance again, switch it off beforehand. Then switch the appliance on again and set the required operation.

Replacing the bulb in the top of the cooking compartment

If the cooking compartment light bulb fails, it must be replaced. Heat-resistant, 40 watt, 230 V halogen bulbs are available from the after-sales service or specialist retailers.

When handling the halogen bulb, use a dry cloth. This will increase the service life of the bulb. Only use these bulbs.

⚠ Warning – Risk of electric shock!

When replacing the cooking compartment bulb, the bulb socket contacts are live. Before replacing the bulb, unplug the appliance from the mains or switch off the circuit breaker in the fuse box.

⚠ Warning – Risk of burns!

The appliance becomes very hot. Never touch the interior surfaces of the cooking compartment or the heating elements. Always allow the appliance to cool down. Keep children at a safe distance.

1. Place a tea towel in the cold cooking compartment to prevent damage.
2. Turn the glass cover anti-clockwise to remove it (figure 1).
3. Pull out the bulb – do not turn it (figure 2). Insert the new bulb, making sure that the pins are in the correct position. Push the bulb in firmly.

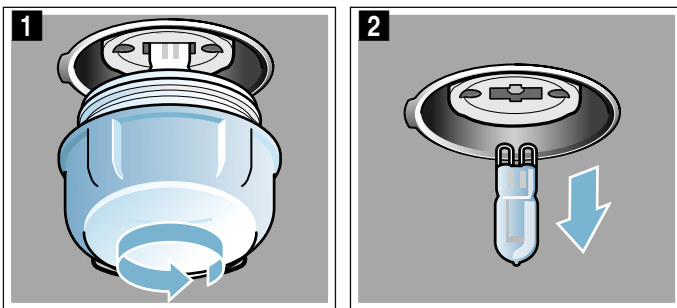

4. Screw the glass cover back on. Depending on the appliance model, the glass cover may have a sealing ring. If the glass cover has a sealing ring, put it back in place before screwing the cover back on.
5. Remove the tea towel and switch on the circuit breaker.

Glass cover

If the glass cover of the halogen bulb is damaged, it must be replaced. You can obtain a new glass cover from the after-sales service. Please specify the E number and FD number of your appliance.

Customer service

Our after-sales service is there for you if your appliance needs to be repaired. We will always find an appropriate solution, also in order to avoid after-sales personnel having to make unnecessary visits.

E number and FD number

When calling us, please quote the full product number (E no.) and the production number (FD no.) so that we can provide you with the correct advice. The rating plate bearing these numbers can be found when you open the appliance door.

On some appliances with a steam-assisted cooking function, you will find the rating plate behind the control panel.

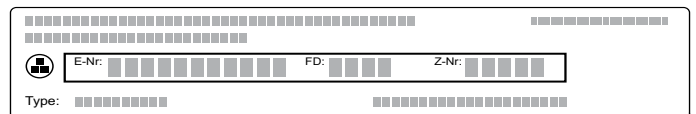

To save time, you can make a note of the numbers for your appliance and the telephone number of the after-sales service in the space below in case you need them.

| | |
|--------------|---------------|
| E no. | FD no. |
|--------------|---------------|

After-sales service ☎

Please note that a visit from an after-sales service engineer is not free of charge in the event that the appliance has been misused, even during the warranty period.

Please find the contact data of all countries in the enclosed customer service list.

To book an engineer visit and product advice

- GB** 0344 892 8989
Calls charged at local or mobile rate.
- IE** 01450 2655
0.03 € per minute at peak. Off peak 0.0088 € per minute.

Rely on the professionalism of the manufacturer. You can therefore be sure that the repair is carried out by trained service technicians who carry original spare parts for your appliances.

Tested for you in our cooking studio

Here, you can find a selection of dishes and the ideal settings for them. We will show you which type of heating and temperature are best suited to your dish. You will get information on suitable cooking accessories and the height at which they should be placed in the oven. You will also get tips about cookware and preparation methods.

Note: A lot of steam can build up in the cooking compartment when cooking food. Your appliance is very energy-efficient and radiates very little heat to its surroundings during operation. Due to the high difference in temperature between the appliance interior and the external parts of the appliance, condensation may build up on the door, control panel or adjacent kitchen cabinet panels. This is a normal physical phenomenon. Condensation can be reduced by preheating the oven or opening the door carefully.

Silicone moulds

For the best cooking results, we recommend dark-coloured metal baking tins/dishes.

Nevertheless, if you wish to use silicone moulds, follow the manufacturer's instructions and recipes. Silicone moulds are often smaller than normal baking tins. Quantity and recipe specifications may vary.

Cakes and small baked items

Your appliance offers you a range of heating types for the preparation of cakes and small baked items. You can find the ideal settings for many dishes in the settings tables.

Also refer to the notes in the section on allowing dough to rise.

Only use original accessories supplied with your appliance. These have been tailored to the cooking compartment and the operating modes of your appliance.

Shelf positions

Use the indicated shelf positions.

Baking on one level

When baking on one level, use the following shelf positions:

- Tall baked items: Level 2
- Flat baked items: Level 3

If you are using CircoTherm Hot air as the type of heating, you can choose between levels 1, 2, 3 and 4.

Baking on several levels

Use CircoTherm. Baked items that are placed into the oven on trays or in baking tins/dishes at the same time will not necessarily be ready at the same time.

Baking on two levels:

- Universal pan: Level 3
Baking tray: Level 1
- Baking tins/dishes on the wire rack
First wire rack: Level 3
Second wire rack: Level 1

Baking on three levels:

- Baking tray: Level 4
Universal pan: Level 3
Baking tray: Level 1

Baking on four levels:

- 4 wire racks with greaseproof paper
First wire rack: Level 4
Second wire rack: Level 3
Third wire rack: Level 2
Fourth wire rack: Level 1

By preparing several dishes at the same time, you can make energy savings of up to 45 per cent. Position baking tins/dishes next to one another or offset and vertically stacked in the cooking compartment.

Accessories

Ensure that you always use suitable accessories and that they are placed in the oven the right way around.

Wire rack

Insert the wire rack with the open side facing the appliance door and the curved lip pointing downwards. Always place ovenware, tins and dishes on the wire rack.

Universal pan or baking tray

Slide the universal pan or the baking tray in carefully as far as the limit stop with the bevelled edge facing the appliance door.

When baking moist cakes or pastries with many toppings, use the universal pan so that any excess liquid does not overflow and make the cooking compartment dirty.

Baking tins

Dark- coloured metal baking tins are most suitable.

Tinplate baking tins, ceramic dishes and glass dishes extend baking time and mean that the baked item will not brown evenly. If you wish to bake using these baking tins/dishes and using top/bottom heating, slide in the tin/dish at level 1.

Greaseproof paper

Only use greaseproof paper that is suitable for the selected temperature. Always cut greaseproof paper to size.

Recommended setting values

The table lists the optimal heating type for various baked items. The temperature and baking time depend on the amount and consistency of the dough/mixture. For this reason, the table specifies setting ranges. Try using the lower values to start with. A lower temperature will result in more even browning. You can use a higher setting next time if necessary.

Note: Baking times cannot be reduced by using higher temperatures. Cakes or small baked items would only be cooked on the outside, and would not be fully baked in the middle.

The setting values apply to food that is placed into a cold cooking compartment; by doing this, you can make energy savings of up to 20 per cent. If you preheat the oven, you can reduce the indicated baking times by several minutes.





Preheating is necessary for selected food, and this is indicated in the table. Do not place your food or accessories into the cooking compartment until it has finished preheating.



































If you wish to follow one of your own recipes when baking, you should use the setting values listed for similar baked items in the table as reference. Additional

information can be found in the baking tips listed after the settings table.

Remove unused accessories from the cooking compartment. This will ensure that you achieve the best possible cooking results and energy savings of up to 20 per cent.

Types of heating used:

-  CircoTherm
-  Top/bottom heating
-  Circotherm intensive
-  Bread baking

| Dish | Accessories/cookware | Shelf position | Heating function | Temperature in °C | Cooking time in mins. |
|--|------------------------------|----------------|---|-------------------|-----------------------|
| Cakes in tins | | | | | |
| Sponge cake, simple | Ring tin/cake tin | 2 |  | 140-160 | 50-70 |
| Sponge cake, simple | Ring tin/cake tin | 2 |  | 150-170 | 50-70 |
| Sponge cake, simple, 2 levels | Ring tin/cake tin | 3+1 |  | 140-160 | 60-80 |
| Sponge cake, delicate | Ring tin/cake tin | 2 |  | 150-170 | 60-80 |
| Fruit flan made from sponge mixture, delicate | Ring/springform cake tin | 2 |  | 160-180 | 40-60 |
| Fruit flan made from sponge mixture, delicate | Ring/springform cake tin | 2 |  | 150-170 | 40-60 |
| Sponge flan base | Flan base tin | 3 |  | 160-180 | 20-30 |
| Sponge flan base | Flan base tin | 3 |  | 150-170 | 20-30 |
| Fruit tart or cheesecake with shortcrust pastry base | Springform cake tin, Ø 26 cm | 2 |  | 170-190 | 60-80 |
| Swiss flan | Pizza tray | 3 |  | 220-240 | 35-45 |
| Swiss flan | Pizza tray | 3 |  | 170-190 | 45-55 |
| Tart | Flan-base cake tin, black | 3 |  | 190-210 | 25-40 |
| Bundt yeast cake | Ring cake tin | 2 |  | 150-170 | 50-70 |
| Bundt yeast cake | Ring cake tin | 2 |  | 150-160 | 50-70 |
| Yeast cake | Springform cake tin, Ø 28 cm | 2 |  | 150-160 | 20-30 |
| Yeast cake | Springform cake tin, Ø 28 cm | 2 |  | 160-170 | 20-30 |
| Sponge base, 2 eggs | Flan base tin | 3 |  | 160-180* | 20-30 |
| Sponge base, 2 eggs | Flan base tin | 3 |  | 150-170* | 20-30 |
| Sponge flan, 3 eggs | Springform cake tin, Ø 26 cm | 2 |  | 160-170* | 25-35 |
| Sponge flan, 3 eggs | Springform cake tin, Ø 26 cm | 2 |  | 160-170* | 30-40 |
| Sponge flan, 6 eggs | Springform cake tin, Ø 28 cm | 2 |  | 150-170* | 30-50 |
| Sponge flan, 6 eggs | Springform cake tin, Ø 28 cm | 2 |  | 150-170* | 30-50 |
| Cakes on baking trays | | | | | |
| Sponge cake with topping | Baking tray | 3 |  | 160-180 | 20-40 |
| Sponge cake with topping | Baking tray | 3 |  | 150-170 | 25-40 |
| Sponge cake, 2 levels | Universal pan + baking tray | 3+1 |  | 140-160 | 30-50 |
| Shortcrust tart with dry topping | Baking tray | 3 |  | 170-190 | 25-35 |
| Shortcrust tart with dry topping, 2 levels | Universal pan + baking tray | 3+1 |  | 160-170 | 35-45 |
| Shortcrust tart with moist topping | Universal pan | 3 |  | 160-180 | 55-65 |
| Shortcrust tart with moist topping | Universal pan | 3 |  | 150-170 | 55-85 |
| Swiss flan | Universal pan | 3 |  | 200-210 | 40-50 |
| Swiss flan | Universal pan | 3 |  | 170-190 | 45-55 |
| Yeast cake with dry topping | Universal pan | 3 |  | 160-180 | 15-20 |
| Yeast cake with dry topping | Universal pan | 3 |  | 150-170 | 25-35 |
| Yeast cake with dry topping, 2 levels | Universal pan + baking tray | 3+1 |  | 150-170 | 20-30 |
| Yeast cake with moist topping | Universal pan | 3 |  | 180-200 | 30-40 |
| * Preheat | | | | | |
| ** Preheat for 5 mins., do not use quick heat function | | | | | |

| Dish | Accessories/cookware | Shelf position | Heating function | Temperature in °C | Cooking time in mins. |
|--|------------------------------|----------------|------------------|-------------------|-----------------------|
| Yeast cake with moist topping | Universal pan | 3 | | 160-170 | 40-50 |
| Yeast cake with moist topping, 2 levels | Universal pan + baking tray | 3+1 | | 150-170 | 45-60 |
| Plaited loaf, savarin | Baking tray | 2 | | 150-160 | 30-40 |
| Plaited loaf, savarin | Baking tray | 2 | | 160-170 | 25-35 |
| Swiss roll | Baking tray | 3 | | 180-200* | 8-15 |
| Swiss roll | Baking tray | 3 | | 180-190* | 15-20 |
| Stollen with 500 g flour | Baking tray | 2 | | 150-170 | 45-60 |
| Stollen with 500 g flour | Baking tray | 3 | | 150-170 | 55-65 |
| Strudel, sweet | Universal pan | 2 | | 190-210 | 55-65 |
| Strudel, sweet | Universal pan | 2 | | 170-180 | 50-60 |
| Strudel, frozen | Universal pan | 3 | | 200-220 | 35-45 |
| Small baked items | | | | | |
| Small cakes | Baking tray | 3 | | 160** | 20-30 |
| Small cakes | Baking tray | 3 | | 150** | 25-35 |
| Small cakes, 2 levels | Universal pan + baking tray | 3+1 | | 150** | 25-35 |
| Small cakes, 3 levels | Baking trays + universal pan | 4+3+1 | | 140** | 35-45 |
| Muffins | Muffin tray | 3 | | 160-180* | 15-25 |
| Muffins | Muffin tray | 3 | | 170-190 | 15-20 |
| Muffins, 2 levels | Muffin trays | 3+1 | | 160-180* | 15-30 |
| Small yeast cakes | Baking tray | 3 | | 160-180 | 25-35 |
| Small yeast cakes | Baking tray | 3 | | 150-170 | 25-35 |
| Small yeast cakes, 2 levels | Universal pan + baking tray | 3+1 | | 150-170 | 25-40 |
| Puff pastry | Baking tray | 3 | | 170-190* | 20-35 |
| Puff pastry | Baking tray | 3 | | 180-200 | 20-35 |
| Puff pastry, 2 levels | Universal pan + baking tray | 3+1 | | 170-190* | 20-45 |
| Puff pastry, 3 levels | Baking trays + universal pan | 4+3+1 | | 170-190* | 20-45 |
| Puff pastry, flat, 4 levels | 4 wire racks | 4+3+2+1 | | 180-200* | 20-35 |
| Choux pastry | Baking tray | 3 | | 200-220 | 30-40 |
| Choux pastry | Baking tray | 3 | | 190-210 | 30-40 |
| Choux pastry, 2 levels | Universal pan + baking tray | 3+1 | | 190-210 | 35-45 |
| Danish pastry | Baking tray | 3 | | 160-180 | 20-30 |
| Danish pastry | Baking tray | 3 | | 170-190 | 15-25 |
| Biscuits | | | | | |
| Viennese whirls | Baking tray | 3 | | 140-150** | 25-40 |
| Viennese whirls | Baking tray | 3 | | 140-150** | 25-40 |
| Whirls, 2 levels | Universal pan + baking tray | 3+1 | | 140-150** | 30-40 |
| Whirls, 3 levels | Baking trays + universal pan | 4+3+1 | | 130-140** | 35-55 |
| Biscuits | Baking tray | 3 | | 150-160 | 15-25 |
| Biscuits | Baking tray | 3 | | 140-160 | 15-30 |
| Biscuits, 2 levels | Universal pan + baking tray | 3+1 | | 140-160 | 15-30 |
| Biscuits, 3 levels | Baking trays + universal pan | 4+3+1 | | 140-160 | 15-30 |
| Meringue | Baking tray | 3 | | 80-90* | 120-150 |
| Meringue, 2 levels | Universal pan + baking tray | 3+1 | | 80-90* | 120-180 |
| Macaroons | Baking tray | 3 | | 90-110 | 20-40 |
| Macaroons, 2 levels | Universal pan + baking tray | 3+1 | | 90-110 | 25-45 |
| Macaroons, 3 levels | Baking trays + universal pan | 4+3+1 | | 90-110 | 30-50 |
| * Preheat | | | | | |
| ** Preheat for 5 mins., do not use quick heat function | | | | | |

Tips on baking

| | |
|---|---|
| You want to find out whether the cake is completely cooked in the middle. | Push a cocktail stick into the highest point on the cake. If the cocktail stick comes out clean with no dough residue, the cake is ready. |
| The cake collapses. | Next time, use less liquid. Alternatively, set the temperature to be 10 °C lower and extend the baking time. Adhere to the specified ingredients and preparation instructions in the recipe. |
| The cake has risen in the middle but is lower around the edge. | Only grease the base of the springform cake tin. After baking, loosen the cake carefully with a knife. |
| The fruit juice overflows. | Next time, use the universal pan. |
| Small baked items stick to one another during baking. | There should be a gap of approx. 2 cm around each item. This gives enough space for the baked items to expand well and brown on all sides. |
| The cake is too dry. | Set the temperature 10 °C higher and shorten the baking time. |
| The cake is generally too light in colour. | If the shelf position and the cookware are correct, then you should increase the temperature if necessary or extend the baking time. |
| The cake is too light on top, and too dark underneath. | Bake the cake one level higher in the oven the next time. |
| The cake is too dark on top, and too light underneath. | Bake the cake one level lower in the oven the next time. Select a lower temperature and extend the baking time. |
| Cakes baked in a tray or tin are too brown at the back. | Place the baking tray in the middle of the accessories, not directly against the back wall. |
| The whole cake is too dark. | Select a lower temperature next time and extend the baking time if necessary. |
| The cake is unevenly browned. | Select a slightly lower temperature. Protruding greaseproof paper can affect the air circulation. Always cut greaseproof paper to size. Ensure that the baking tin does not stand directly in front of the openings in the cooking compartment back wall. When baking small items, you should use similar sizes and thicknesses wherever possible. |
| You were baking on several levels. The items on the top baking tray are darker than those on the lower baking tray. | Always use CircoTherm when baking on several levels. Baked items that are placed into the oven on trays or in baking tins/dishes at the same time will not necessarily be ready at the same time. |
| The cake looks good, but is not cooked properly in the middle. | Use a lower temperature and bake slightly longer; if necessary, add slightly less liquid. For cakes with a moist topping, bake the base first. Sprinkle it with almonds or breadcrumbs and then place the topping on top. |
| The cake cannot be turned out of the dish when it is turned upside down. | Allow the cake to cool down for 5 to 10 minutes after baking. If it still sticks, carefully loosen the cake around the edges again using a knife. Turn the cake tin upside down again and cover it several times with a cold, wet cloth. Next time, grease the baking tin/dish and sprinkle with breadcrumbs. |

Bread and rolls

Your appliance offers you a range of heating types for baking bread and rolls. You can find the ideal settings for many dishes in the settings tables.

Also refer to the notes in the section on allowing dough to rise.

Only use original accessories supplied with your appliance. These have been tailored to the cooking compartment and the operating modes of your appliance.

Shelf positions

Use the indicated shelf positions.

Baking on one level

When baking on one level, use the following shelf positions:

- Tall baked items: Level 2
- Flat baked items: Level 3

If you are using CircoTherm Hot air as the type of heating, you can choose between levels 1, 2, 3 and 4.

Baking on two levels

Use CircoTherm. Baked items that are placed into the oven on trays or in baking tins/dishes at the same time will not necessarily be ready at the same time.

- Universal pan: Level 3
Baking tray: Level 1
- Baking tins/dishes on the wire rack
First wire rack: Level 3
Second wire rack: Level 1

By preparing several dishes at the same time, you can make energy savings of up to 45 per cent. Position baking tins/dishes next to one another or offset and vertically stacked in the cooking compartment.

Accessories

Ensure that you always use suitable accessories and that they are placed in the oven the right way around.

Wire rack

Insert the wire rack with the open side facing the appliance door and the curved lip pointing downwards. Always place ovenware, tins and dishes on the wire rack.

Universal pan or baking tray

Slide the universal pan or the baking tray in carefully as far as the limit stop with the bevelled edge facing the appliance door.

Baking tins

Dark- coloured metal baking tins are most suitable.

Tinplate baking tins, ceramic dishes and glass dishes extend baking time and mean that the baked item will not brown evenly. If you wish to bake using these baking tins/dishes and using top/bottom heating, slide in the tin/dish at level 1.

Greaseproof paper

Only use greaseproof paper that is suitable for the selected temperature. Always cut greaseproof paper to size.

Frozen products

Do not use frozen products that are heavily frosted. Remove any ice on the food.

Some frozen products may be unevenly pre-baked. Uneven browning may remain even after baking.

Recommended setting values

The table lists the optimal heating type for various kinds of bread and bread roll. The temperature and baking time depend on the amount and consistency of the dough/mixture. For this reason, the table specifies setting ranges. Try using the lower values to start with. A lower temperature will result in more even browning. You can use a higher setting next time if necessary.

Note: Baking times cannot be reduced by using higher temperatures. The bread or bread rolls would only be cooked on the outside, but would not be fully baked in the middle.

The setting values apply to food that is placed into a cold cooking compartment; by doing this, you can make energy savings of up to 20 per cent. If you preheat the oven, you can reduce the indicated baking times by several minutes.

Preheating is necessary for selected food, and this is indicated in the table. Do not place your food or accessories into the cooking compartment until it has finished preheating. Some food turns out best if it is baked in several stages. These foods are indicated in the table.

The setting values for bread dough apply to both dough placed on a baking tray and dough placed in a loaf tin.

If you wish to follow one of your own recipes when baking, you should use the setting values listed for similar baked items in the table as reference.











Remove unused accessories from the cooking compartment. This will ensure that you achieve the best possible cooking results and energy savings of up to 20 per cent.

Caution!











Never pour water into the hot cooking compartment or place cookware containing water onto the bottom of the cooking compartment. The change in temperature can cause damage to the enamel.

Types of heating used:

-  CircoTherm
-  Top/bottom heating
-  Circo-roasting
-  Circotherm intensive
-  Bread baking
-  Full-surface grill

| Dish | Accessories | Shelf position | Type of heating | Temperature in °C | Cooking time in mins. |
|--|---------------------------|----------------|---|-------------------|-----------------------|
| Bread | | | | | |
| White bread, 750 g | Universal pan or cake tin | 2 |  | 180-200* | 30-40 |
| White bread, 750 g | Universal pan or cake tin | 2 |  | 210-220* | 10-15 |
| | | | | 180-190* | 25-35 |
| Multigrain bread, 1.5 kg | Universal pan or cake tin | 2 |  | 210-220* | 10-15 |
| | | | | 180-190* | 40-50 |
| Multigrain bread, 1.5 kg | Universal pan or cake tin | 2 |  | 230-240* | 10-15 |
| | | | | 200-210* | 40-50 |
| Wholemeal bread, 1 kg | Universal pan | 2 |  | 210-220* | 10-15 |
| | | | | 180-190* | 40-50 |
| Wholemeal bread, 1 kg | Universal pan | 2 |  | 230-240* | 10-15 |
| | | | | 200-210* | 40-50 |
| Flatbread | Universal pan | 3 |  | 250-270 | 20-25 |
| Flatbread | Universal pan | 3 |  | 220-240 | 25-35 |
| Bread rolls | | | | | |
| Part-cooked rolls or baguette, pre-baked | Universal pan | 3 |  | 180-200 | 10-15 |
| Bread rolls, sweet, fresh | Baking tray | 3 |  | 170-190* | 15-20 |

* Preheat

| Dish | Accessories | Shelf position | Type of heating | Temperature in °C | Cooking time in mins. |
|--|-----------------------------|----------------|---|-------------------|-----------------------|
| Bread rolls, sweet, fresh | Baking tray | 3 |  | 150-170* | 15-25 |
| Bread rolls, sweet, fresh, 2 levels | Universal pan + baking tray | 3+1 |  | 150-170* | 20-30 |
| Bread rolls, fresh | Baking tray | 3 |  | 180-200 | 20-30 |
| Bread rolls, fresh | Baking tray | 3 |  | 170-190 | 20-30 |
| Baguette, pre-baked, chilled | Universal pan | 3 |  | 180-200 | 20-30 |
| Bread rolls, frozen | | | | | |
| Part-cooked rolls or baguette, pre-baked | Universal pan | 3 |  | 180-200 | 10-15 |
| Lye bread, pieces of dough | Universal pan | 3 |  | 180-200 | 20-25 |
| Croissant, pieces of dough | Universal pan | 3 |  | 170-190 | 30-35 |
| Toast | | | | | |
| Toast with topping, 4 slices | Wire rack | 3 |  | 190-210 | 10-15 |
| Toast with topping, 12 slices | Wire rack | 3 |  | 230-250 | 10-15 |
| Toasting bread (do not preheat) | Wire rack | 4 |  | 290 | 4-6 |
| * Preheat | | | | | |

Pizza, quiche and savoury cakes

Your appliance offers you a range of heating types for preparing pizza, quiche and savoury cakes. You can find the ideal settings for many dishes in the settings tables.

Also refer to the notes in the section on allowing dough to rise.

Only use original accessories supplied with your appliance. These have been tailored to the cooking compartment and the operating modes of your appliance.

Shelf positions

Use the indicated shelf positions.

Baking on one level

When baking on one level, use the following shelf positions:

- Tall baked items: Level 2
- Flat baked items: Level 3

If you are using CircoTherm Hot air as the type of heating, you can choose between levels 1, 2, 3 and 4.

Baking on several levels

Use CircoTherm. Baked items that are placed into the oven on trays or in baking tins/dishes at the same time will not necessarily be ready at the same time.

Baking on two levels:

- Universal pan: Level 3
Baking tray: Level 1
- Baking tins/dishes on the wire rack
First wire rack: Level 3
Second wire rack: Level 1

Baking on four levels:

- 4 wire racks with greaseproof paper
First wire rack: Level 4
Second wire rack: Level 3
Third wire rack: Level 2
Fourth wire rack: Level 1

By preparing several dishes at the same time, you can make energy savings of up to 45 per cent. Position baking tins/dishes next to one another or offset and vertically stacked in the cooking compartment.

Accessories

Ensure that you always use suitable accessories and that they are placed in the oven the right way around.

Wire rack

Insert the wire rack with the open side facing the appliance door and the curved lip pointing downwards. Always place ovenware, tins and dishes on the wire rack.

Universal pan or baking tray

Slide the universal pan or the baking tray in carefully as far as the limit stop with the bevelled edge facing the appliance door.

Use the universal pan for pizzas with many toppings.

Baking tins

Dark- coloured metal baking tins are most suitable.

Tinplate baking tins, ceramic dishes and glass dishes extend baking time and mean that the baked item will not brown evenly. If you wish to bake using these baking tins/dishes and using top/bottom heating, slide in the tin/dish at level 1.

Greaseproof paper

Only use greaseproof paper that is suitable for the selected temperature. Always cut greaseproof paper to size.

Frozen products

Do not use frozen products that are heavily frosted. Remove any ice on the food.

Some frozen products may be unevenly pre-baked. Uneven browning may remain even after baking.

Recommended setting values

The table lists the optimal heating type for various types of food. The temperature and baking time depend on the amount and consistency of the dough/mixture. For this reason, the table specifies setting ranges. Try using the lower values to start with. A lower temperature will result in more even browning. You can use a higher setting next time if necessary.

Note: Baking times cannot be reduced by using higher temperatures. The food would only be cooked on the outside, but would not be fully baked in the middle.





The setting values apply to food that is placed into a cold cooking compartment; by doing this, you can make energy savings of up to 20 per cent. If you preheat the oven, you can reduce the indicated baking times by several minutes.





















Preheating is necessary for selected food, and this is indicated in the table. Do not place your food or accessories into the cooking compartment until it has finished preheating.

If you wish to follow one of your own recipes when baking, you should use the setting values listed for similar baked items in the table as reference.

Remove unused accessories from the cooking compartment. This will ensure that you achieve the best possible cooking results and energy savings of up to 20 per cent.

Types of heating used:

-  CircoTherm
-  Top/bottom heating
-  Circotherm intensive
-  Bread baking

| Dish | Accessories | Shelf position | Type of heating | Temperature in °C | Cooking time in mins. |
|--------------------------------------|-------------------------------------|----------------|---|-------------------|-----------------------|
| Pizza | | | | | |
| Pizza, fresh | Baking tray | 3 |  | 200-220 | 25-35 |
| Pizza, fresh, 2 levels | Universal pan + baking tray | 3+1 |  | 180-200 | 35-45 |
| Pizza, fresh, thin base | Pizza tray | 2 |  | 220-230 | 20-30 |
| Pizza, chilled | Wire rack | 3 |  | 190-210 | 10-15 |
| Pizza, frozen | | | | | |
| Pizza with thin base x 1 | Wire rack | 3 |  | 190-210 | 15-20 |
| Pizza with thin base x 2 | Universal pan + wire rack | 3+1 |  | 190-210 | 20-25 |
| Pizza, deep-pan, x 1 | Wire rack | 3 |  | 180-200 | 20-25 |
| Pizza, deep-pan, x 2 | Universal pan + wire rack | 3+1 |  | 190-210 | 20-30 |
| Pizza baguette | Wire rack | 3 |  | 200-220 | 15-20 |
| Mini pizzas | Universal pan | 3 |  | 180-200 | 15-20 |
| Mini pizzas, diameter 7 cm, 4 levels | 4 wire racks | 4+3+2+1 |  | 180-200* | 20-30 |
| Savoury cakes and quiches | | | | | |
| Savoury cakes in a tin | Springform cake tin, diameter 28 cm | 2 |  | 170-190 | 50-60 |
| Savoury cakes in a tin | Springform cake tin, diameter 28 cm | 2 |  | 170-190 | 55-65 |
| Quiche | Flan-base cake tin, black | 3 |  | 190-210 | 30-40 |
| Tarte flambée | Universal pan | 3 |  | 260-280* | 10-15 |
| Tarte flambée | Universal pan | 3 |  | 200-210* | 15-25 |
| Pierogi | Ovenproof dish | 2 |  | 190-200 | 30-45 |
| Pierogi | Ovenproof dish | 2 |  | 170-190 | 50-70 |
| Empanada | Universal pan | 3 |  | 180-190 | 30-45 |
| Börek | Universal pan | 2 |  | 180-200 | 35-45 |
| Börek | Universal pan | 1 |  | 200-220* | 20-30 |
| * Preheat | | | | | |

Bakes and soufflés

Your appliance offers a range of heating types for preparing bakes and soufflés. You can find the ideal settings for many dishes in the settings tables.

Only use original accessories supplied with your appliance. These have been tailored to the cooking compartment and the operating modes of your appliance.

Shelf positions

Always use the indicated shelf positions.

You can prepare dishes on one level using a baking tin/dish or the universal pan.

- Baking tins/dishes on the wire rack: Level 2
- Universal pan: Level 3

You can also prepare soufflés in a water bath in the universal pan. To do so, slide the universal pan in at level 2.

By preparing several dishes at the same time, you can make energy savings of up to 45 per cent. Position baking tins/dishes next to one another in the cooking compartment.

Accessories

Ensure that you always use suitable accessories and that they are placed in the oven the right way around.

Wire rack

Insert the wire rack with the open side facing the appliance door and the curved lip pointing downwards. Always place ovenware, tins and dishes on the wire rack.

Universal pan











Slide in the universal pan carefully as far as the limit stop, with the bevelled edge facing the appliance door.

Cookware

Use wide, shallow cookware for bakes and gratins. In deep, narrow cookware, food requires more time to cook, and the top will be darker.

Recommended setting values

In the table, you can find the ideal heating type for various bakes and soufflés. The temperature and cooking time are dependent on the quantity of food and the recipe. How well cooked a bake is will depend on the size of the cookware and the depth of the bake.

| Bakes & soufflés | Accessories/cookware | Shelf position | Type of heating | Temperature in °C | Cooking time in mins. |
|---|----------------------|----------------|---|-------------------|-----------------------|
| Bake, savoury, cooked ingredients | Ovenproof dish | 2 |  | 170-190 | 35-50 |
| Bake, savoury, cooked ingredients | Ovenproof dish | 2 |  | 200-220 | 30-50 |
| Bake, sweet | Ovenproof dish | 2 |  | 160-180 | 40-50 |
| Bake, sweet | Ovenproof dish | 2 |  | 170-190 | 40-60 |
| Lasagne, fresh, 1 kg | Ovenproof dish | 2 |  | 170-190 | 50-60 |
| Lasagne, fresh, 1 kg | Ovenproof dish | 2 |  | 160-180 | 50-60 |
| Lasagne, frozen, 400 g | Wire rack | 2 |  | 190-210 | 30-35 |
| Potato gratin, raw ingredients, 4 cm deep | Ovenproof dish | 2 |  | 160-190 | 50-70 |
| Potato gratin, raw ingredients, 4 cm deep, 2 levels | Ovenproof dish | 3+1 |  | 150-170 | 60-80 |
| Soufflé | Ovenproof dish | 2 |  | 160-180* | 35-45 |
| Soufflé | Individual moulds | 2 |  | 170-190 | 65-75 |

Poultry

Your appliance offers you a range of heating types for preparing poultry. You can find the ideal settings for certain dishes in the settings tables.

Roasting on the wire rack

Roasting on the wire rack is particularly well suited for larger poultry or for multiple pieces at the same time.

Slide the universal pan into the oven at the indicated shelf position with the wire rack attached. Ensure that the wire rack is correctly positioned on the universal pan. → "Accessories" on page 10

Depending on the size and type of the poultry, pour up to ½ litres of water into the universal pan. Any dripping fat will be caught. You can make a sauce from these juices. This will also result in less smoke and ensure that the cooking compartment stays cleaner.

Settings ranges are indicated for this reason. Try using the lower values at first. A lower temperature results in more even browning. You can increase the temperature next time if necessary.





Note: Cooking times cannot be reduced by using higher temperatures. Bakes or soufflés would only be cooked on the outside, but would be raw in the middle.

The setting values apply to dishes placed into a cold cooking compartment. By doing so, you can make energy savings of up to 20 per cent. If you preheat the oven, the indicated cooking times will be reduced by several minutes.

If you wish to follow one of your own recipes when cooking, you can use similar dishes in the table as a reference.

Remove unused accessories from the cooking compartment. This will achieve the best possible cooking results and energy savings of up to 20 per cent.

Types of heating used:

-  CircoTherm
-  Top/bottom heating
-  CircoTherm intensive
-  Bread baking

Roasting in cookware

Only use cookware which is suitable for use in an oven. Check whether the cookware fits in the cooking compartment.

Glass cookware is most suitable. Place hot glass cookware onto a dry mat after cooking. If the surface is damp or cold, the glass may crack.

Shiny roasting dishes made from stainless steel or aluminium reflect heat like a mirror and are therefore not particularly suitable. The poultry cooks slower and does not brown so well. Use a higher temperature and/or a longer cooking time.

Observe the manufacturer's instructions for your roasting cookware.

Uncovered cookware

It is best to use a deep roasting tin/dish for roasting poultry. Place the tin/dish onto the wire rack. If you do not have any suitable cookware, use the universal pan.

Covered cookware

When cooking with covered cookware, the cooking compartment remains considerably cleaner. Ensure that the lid fits well and closes properly. Place the cookware onto the wire rack.

Very hot steam may escape when opening the lid after cooking. Lift the lid at the rear, so that the hot steam can escape away from you.

Poultry can also become crispy in a covered roasting dish. To do so, use a roasting dish with a glass lid and set a higher temperature.

Grilling

Keep the appliance door closed when using the grill. Never grill with the appliance door open.

Place the food to be grilled on the wire rack. In addition, slide the universal pan in at least one shelf position lower, with the slanted edge facing the appliance door. Any dripping fat will be caught.

When grilling, try wherever possible to use pieces of food which are of a similar thickness and weight. This will allow them to brown evenly and remain succulent and juicy. Place the food to be grilled directly onto the wire rack.

Use tongs to turn the pieces of food you are grilling. If you pierce the meat with a fork, the juices will run out and it will become dry.

Notes

- The grill element switches itself continuously on and off; this is normal. The set temperature determines how frequently this occurs.
- Smoke may be produced when grilling.

Recommended setting values

In the table, you can find the ideal heating type for the kind of poultry you are cooking. The temperature and cooking time depend on the amount, composition and temperature of the food. Setting ranges are indicated

for this reason. Try using the lower values at first. You can increase the temperature next time if necessary.

The setting values are based on the assumption that unstuffed, chilled, ready-to-roast poultry is placed into a cold cooking compartment. By doing so, you can make energy savings of up to 20 per cent. If you preheat the oven, the indicated cooking times will be reduced by several minutes.

In the table, you can find specifications for poultry with default values for the weight. If you wish to cook heavier poultry, use the lower temperature in every case. If cooking multiple pieces, use the weight of the heaviest piece as a reference for determining the cooking time. The individual pieces should be approximately equal in size.

A general rule: the larger the poultry is, the lower the cooking temperature and the longer the cooking time.

Turn the poultry after approx. 1/2 to 2/3 of the indicated time.





Note: Only use greaseproof paper that is suitable for the selected temperature. Always cut greaseproof paper to size.









Tips



- For duck or goose, pierce the skin on the underside of the wings. This allows the fat to run out.
- If using duck breast, score the skin. Do not turn duck breasts.
- When you turn poultry, ensure that the breast side or the skin side is underneath at first.
- Poultry will turn out particularly crispy and brown if you baste it towards the end of the roasting time with butter, salted water or orange juice.

Remove unused accessories from the cooking compartment. This will achieve the best possible cooking results and energy savings of up to 20 per cent.

Types of heating used:

-  Top/bottom heating
-  Circo-roasting
-  Circotherm intensive
-  Full-surface grill

| Dish | Accessories/cookware | Shelf position | Type of heating | Temperature in °C | Cooking time in mins. |
|--|----------------------|----------------|---|-------------------|-----------------------|
| Chicken | | | | | |
| Chicken, 1 kg | Wire rack | 2 |  | 200-220 | 60-70 |
| Chicken breast fillet, 150 g each (grilling) | Wire rack | 4 |  | 275* | 15-20 |
| Small chicken portions, 250 g each | Wire rack | 3 |  | 220-230 | 30-35 |
| Chicken goujons, nuggets, frozen | Universal pan | 3 |  | 190-210 | 20-25 |
| Poulard, 1.5 kg | Wire rack | 2 |  | 200-220 | 70-90 |
| Duck and goose | | | | | |
| Duck, 2 kg | Wire rack | 1 |  | 180-200 | 90-110 |
| Duck breast, 300 g each | Wire rack | 3 |  | 230-250 | 25-30 |
| Goose, 3 kg | Wire rack | 2 |  | 160-180 | 120-150 |
| Goose legs, 350 g each | Wire rack | 2 |  | 210-230 | 40-50 |
| * Preheat for 5 mins | | | | | |

| Dish | Accessories/cookware | Shelf position | Type of heating | Temperature in °C | Cooking time in mins. |
|-------------------------------|----------------------|----------------|---|-------------------|-----------------------|
| Turkey | | | | | |
| Small turkey, 2.5 kg | Wire rack | 2 |  | 180-200 | 70-90 |
| Turkey breast, boned, 1 kg | Cookware, covered | 2 |  | 240-260 | 80-100 |
| Turkey thigh, with bone, 1 kg | Wire rack | 2 |  | 180-200 | 80-100 |
| * Preheat for 5 mins | | | | | |

Meat

Your appliance offers you many heating types for preparing meat. You can find the ideal settings for many dishes in the settings tables.

Roasting and braising

Baste lean meat with fat as required or cover it with strips of bacon.

Score the rind crosswise. If you turn the joint when cooking, ensure that the rind is underneath at first.

When the joint is ready, turn off the oven and allow it to rest for another 10 minutes in the cooking compartment. This allows the meat juices to be better distributed. Wrap the joint in aluminium foil if necessary. The recommended standing time is not included in the cooking time specified.

Roasting on the wire rack

On the wire rack, meat will become very crispy on all sides.

Pour up to ½ litres of water into the universal pan, depending on the size and type of the meat. Dripping fat and meat juices will be caught. You can make a sauce using these juices. This will also result in less smoke and ensure that the cooking compartment stays cleaner.

Slide the universal pan into the oven at the indicated shelf position with the wire rack attached. Ensure that the wire rack is correctly positioned on the universal pan. → "Accessories" on page 10

Roasting and braising in cookware

It is more convenient to roast and braise meat in cookware. You can take the joint out of the cooking compartment more easily in the cookware, and prepare the sauce in the cookware itself.

Only use cookware which is suitable for use in an oven. Check whether the cookware fits in the cooking compartment.

Glass cookware is most suitable. Place hot glass cookware onto a dry mat after cooking. If the surface is damp or cold, the glass may crack.

Add in a little liquid for roasting if the meat is lean. A covering of approx. ½ cm depth should be applied to the base of any glass cookware.

The amount of liquid is dependent on the type of meat, the cookware material and also on whether or not a lid is used. If preparing meat in an enamelled or dark metal roasting dish, it will need a little more liquid than if cooked in glass cookware.

The steam evaporates in the cookware when roasting. Carefully pour in more liquid if required.

Shiny roasting dishes made from stainless steel or aluminium reflect heat like a mirror and are therefore not particularly suitable. The meat cooks more slowly and will not brown so much. Use a higher temperature and/or a longer cooking time.

Observe the manufacturer's instructions for your roasting cookware.

Uncovered cookware

Use a deep roasting tin/dish for roasting meat. Place the tin/dish onto the wire rack. If you do not have any suitable cookware, use the universal pan.

Covered cookware

When cooking with covered cookware, the cooking compartment remains considerably cleaner. Ensure that the lid fits well and closes properly. Place the cookware onto the wire rack.

The distance between the meat and the lid must be at least 3 cm. The meat may rise.

Very hot steam may escape when opening the lid after cooking. Lift the lid at the rear, so that the hot steam can escape away from you.

If necessary, braise the meat first by searing it. Add water, wine, vinegar or a similar liquid to the braising liquid. A covering approx. 1-2 cm deep should be applied to the base of the cookware.

The steam evaporates in the cookware when roasting. Carefully pour in more liquid if required.

Meat can also become crispy in a covered roasting dish. To do so, use a roasting dish with a glass lid and set a higher temperature.

Grilling

Keep the appliance door closed when using the grill. Never grill with the appliance door open.

Place the food to be grilled on the wire rack. In addition, slide the universal pan in at least one shelf position lower, with the slanted edge facing the appliance door. Any dripping fat will be caught.

When grilling, try wherever possible to use pieces of food which are of a similar thickness and weight. This will allow them to brown evenly and remain succulent and juicy. Place the food to be grilled directly onto the wire rack.

Use tongs to turn the pieces of food you are grilling. If you pierce the meat with a fork, the juices will run out and it will become dry.

Do not add salt until after the meat has been grilled. Salt draws water from the meat.

Notes

- The grill element switches itself continuously on and off; this is normal. The set temperature determines how frequently this occurs.
- Smoke may be produced when grilling.

Recommended setting values

You can find the ideal heating type for many meat dishes in the table. Temperature and cooking time depend on the amount, composition and temperature of the food. Settings ranges are indicated for this reason. Try using the lower values at first. You can increase the temperature next time if necessary.

The setting values apply to chilled meat placed into the cold cooking compartment. By doing so, you can make energy savings of up to 20 per cent. If you preheat the oven, you can reduce the indicated cooking times by several minutes.

You can find information on roasts and default values for weights in the table. If you wish to roast a heavy joint of meat, you should definitely use a lower temperature. If roasting several joints, use the weight of the heaviest

piece as a basis for determining the cooking time. The individual pieces should be approximately equal in size.



As a general rule: the larger a roasting joint is, the lower the cooking temperature and the longer the cooking time.



















Turn roasting joints and grilled items after approx. $\frac{1}{2}$ to $\frac{2}{3}$ of the indicated time.

If you wish to follow one of your own recipes, you should use similar dishes as a reference. You can find additional information in the tips on roasting, braising and grilling attached to the settings table.

Remove unused accessories from the cooking compartment. This will achieve the best possible cooking results and energy savings of up to 20 per cent.

Types of heating used:

-  Top/bottom heating
-  Circo-roasting
-  Full-surface grill

| Dish | Accessories/cookware | Shelf position | Type of heating | Temperature in °C | Cooking time in mins. |
|--|----------------------|----------------|---|-------------------|-----------------------|
| Pork | | | | | |
| Joint of pork without rind, e.g. neck, 1.5 kg | Cookware, uncovered | 2 |  | 180-190 | 110-130 |
| Joint of pork with rind, e.g. shoulder, 2 kg | Wire rack | 2 |  | 190-200 | 130-140 |
| Pork tenderloin steak, 1.5 kg | Cookware, uncovered | 2 |  | 220-230 | 70-80 |
| Fillet of pork, 400 g | Wire rack | 3 |  | 220-230 | 20-25 |
| Smoked pork on the bone, 1 kg (with a little added water) | Cookware, covered | 2 |  | 210-230 | 70-90 |
| Pork steaks, 2 cm thick | Wire rack | 4 |  | 275 | 16-20 |
| Pork medallions, 3 cm thick | Wire rack | 4 |  | 290* | 10-14 |
| Beef | | | | | |
| Fillet of beef, medium, 1 kg | Wire rack | 2 |  | 210-220 | 40-50 |
| Pot-roasted beef, 1.5 kg | Cookware, covered | 2 |  | 200-220 | 130-160 |
| Sirloin, medium, 1.5 kg | Wire rack | 2 |  | 220-230 | 60-70 |
| Steak, 3 cm thick, medium | Wire rack | 4 |  | 290 | 15-20 |
| Burger, 3-4 cm thick | Wire rack | 4 |  | 290 | 25-30 |
| Veal | | | | | |
| Joint of veal, 1.5 kg | Cookware, uncovered | 2 |  | 160-170 | 100-120 |
| Knuckle of veal, 1.5 kg | Cookware, uncovered | 2 |  | 200-210 | 100-120 |
| Lamb | | | | | |
| Leg of lamb, boned, medium, 1.5 kg | Cookware, uncovered | 2 |  | 170-190 | 50-80 |
| Saddle of lamb on the bone*** | Wire rack | 2 |  | 180-190 | 40-50 |
| Lamb cutlet** | Wire rack | 4 |  | 290 | 14-18 |
| Sausages | | | | | |
| Grilled sausages | Wire rack | 4 |  | 290 | 10-15 |
| Meat dishes | | | | | |
| Meat loaf, 1 kg | Cookware, uncovered | 2 |  | 170-180 | 60-70 |
| * Preheat | | | | | |
| ** Slide the universal pan in underneath at shelf position 2 | | | | | |
| *** Do not turn | | | | | |

Tips on roasting and braising

| | |
|---|--|
| The cooking compartment becomes very dirty. | Prepare your food in an enclosed roasting dish with higher temperature or use the grill tray. You will achieve the best roasting results if you use the grill tray. The grill tray can be bought later as a special accessory. |
| The roast is too dark and the crackling is burned in places, and/or the roast is too dry. | Check the shelf position and temperature. Select a lower temperature the next time and reduce the roasting time if necessary. |
| The crackling is too thin. | Increase the temperature or switch on the grill briefly at the end of the roasting time. |
| The roast looks good but the juices are burnt. | Next time, use a smaller roasting dish and add more liquid if necessary. |
| The roast looks good but the juices are too clear and watery. | Next time, use a larger roasting dish and add less liquid if necessary. |
| The meat gets burned during braising. | The roasting dish and lid must fit together well and close properly. Reduce the temperature and add more liquid when braising if necessary. |

Fish

Your appliance offers you a range of heating types for preparing fish. You can find the ideal settings for many dishes in the settings tables.

The whole fish does not have to be turned. Place the whole fish into the cooking compartment in swimming position with the dorsal fin facing upwards. Placing half a potato or a small oven-proof container in the stomach cavity of the fish will provide stability.

You can tell when the fish is cooked because the dorsal fin can be removed easily.

Roasting and grilling on the wire rack

Place the food to be grilled on the wire rack. In addition, slide the universal pan in at least one shelf position lower, with the slanted edge facing the appliance door.

Pour up to ½ litres of water into the universal pan, depending on the size and type of the fish. Any dripping liquid will be caught. Less smoke is generated and the cooking compartment stays cleaner.

Keep the appliance door closed when using the grill. Never grill with the appliance door open.

When grilling, try wherever possible to use pieces of food which are of a similar thickness and weight. This will allow them to brown evenly and remain succulent and juicy. Place the food to be grilled directly onto the wire rack.

Use tongs to turn the pieces of food you are grilling. If you pierce the fish with a fork, the juices will run out and it will become dry.

Notes

- The grill element switches itself continuously on and off; this is normal. The set temperature determines how frequently this occurs.
- Smoke may be produced when grilling.

Roasting and stewing in cookware

Only use cookware which is suitable for use in an oven. Check whether the cookware fits in the cooking compartment.

Glass cookware is most suitable. Place hot glass cookware onto a dry mat after cooking. If the surface is damp or cold, the glass may crack.

Shiny roasting dishes made from stainless steel or aluminium reflect heat like a mirror and are therefore not particularly suitable. The fish cooks more slowly and browns less. Use a higher temperature and/or a longer cooking time.

Observe the manufacturer's instructions for your roasting cookware.

Uncovered cookware

To cook a whole fish, it is best to use a deep roasting tin/dish. Place the tin/dish onto the wire rack. If you do not have any suitable cookware, use the universal pan.

Covered cookware

When cooking with covered cookware, the cooking compartment remains considerably cleaner. Ensure that the lid fits well and closes properly. Place the cookware onto the wire rack.

When stewing, add two to three tablespoons of liquid and a little lemon juice or vinegar into the cookware.

Very hot steam may escape when opening the lid after cooking. Lift the lid at the rear, so that the hot steam can escape away from you.

Fish can also become crispy in a covered roasting dish. Here, use a roasting dish with a glass lid and set a higher temperature.

Recommended setting values

You can find the ideal heating type for your fish dishes in the table. The temperature and cooking time depend on the amount, composition and temperature of the food. Settings ranges are indicated for this reason. Try using lower setting values first. You can use a higher setting next time if necessary.

The setting values are based on the assumption that chilled fish is placed into a cold cooking compartment. By doing so, you can make energy savings of up to 20 per cent. If you preheat the oven, you can reduce the indicated cooking times by several minutes.

In the table, you can find information for fish with default values for the weight. If you want to cook a heavier fish, you should definitely use the lower temperature. If cooking several fish, you should use the weight of the heaviest fish as a reference for determining the cooking time. The individual fish should be approximately the same size.



As a general rule: the larger a fish, the lower the cooking temperature and the longer the cooking time.







Turn any fish which is not in swimming position after approx. $\frac{1}{2}$ to $\frac{2}{3}$ of the indicated time.

Note: Only use greaseproof paper that is suitable for the selected temperature. Always cut greaseproof paper to size.

Remove unused accessories from the cooking compartment. This will achieve the best possible cooking results and energy savings of up to 20 per cent.

Types of heating used:

-  Top/bottom heating
-  Circo-roasting
-  Full-surface grill

| Dish | Accessories/cookware | Shelf position | Type of heating | Temperature in °C | Cooking time in mins. |
|--|----------------------|----------------|--|-------------------|-----------------------|
| Fish | | | | | |
| Fish, grilled, whole 300 g, e.g. trout | Wire rack | 2 |  | 170-190 | 20-30 |
| Fish, grilled, whole 1.5 kg, e.g. salmon | Wire rack | 2 |  | 170-190 | 30-40 |
| Fish fillets | | | | | |
| Fish fillet, plain, grilled | Wire rack | 4 |  | 220* | 15-25 |
| Fish steaks | | | | | |
| Fish steak, 3 cm thick** | Wire rack | 4 |  | 290 | 10-20 |
| Fish, frozen | | | | | |
| Fish fillet, plain | Cookware, covered | 2 |  | 210-230 | 20-30 |
| Fish fillet, au gratin | Wire rack | 2 |  | 200-220 | 45-60 |
| Fish fingers (turn during cooking) | Universal pan | 3 |  | 200-220 | 20-30 |
| * Preheat | | | | | |
| ** Slide the universal pan in underneath at shelf position 2 | | | | | |

Vegetables and side dishes

Here, you can find information for preparing grilled vegetables, potatoes and frozen potato products.

Remove unused accessories from the cooking compartment. This will allow you to achieve ideal cooking results and save energy.

Shelf positions

Use the indicated shelf positions.

Cooking on one level

Adhere to the specifications in the table.

Cooking on two levels

Use CircoTherm. Food on baking trays that are placed in the oven at the same time will not necessarily be ready at the same time.

- Universal pan: Level 3
- Baking tray: Level 1

Accessories

Ensure that you always use suitable accessories and that they are placed in the oven the right way around.

Wire rack

Insert the wire rack with the open side facing the appliance door and the curved lip pointing downwards. Always place ovenware, tins and dishes on the wire rack.

Universal pan or baking tray

Slide the universal pan or the baking tray in carefully as far as the limit stop with the bevelled edge facing the appliance door.

Greaseproof paper

Only use greaseproof paper that is suitable for the selected temperature. Always cut greaseproof paper to size.



Recommended setting values

In the table, you can find the ideal heating types for various dishes. The temperature and cooking time depend on the amount and composition of the food. Setting ranges are indicated for this reason. Try using the lower values at first. A lower temperature results in more even browning. You can use a higher setting next time if necessary.

The setting values apply to dishes placed into a cold cooking compartment. If you preheat the oven, the indicated cooking times will be reduced by several minutes.

If you wish to follow one of your own recipes when cooking, you can use similar dishes in the table as a reference.

Types of heating used:

-  CircoTherm
-  Circotherm intensive

-  Bread baking
-  Full-surface grill

| Dish | Accessories | Shelf position | Type of heating | Temperature in °C | Cooking time in mins. |
|--------------------------------|-----------------------------|----------------|---|-------------------|-----------------------|
| Vegetable dishes | | | | | |
| Grilled vegetables | Universal pan | 4 |  | 290 | 10-15 |
| Potatoes | | | | | |
| Baked potatoes, halved | Universal pan | 3 |  | 160-180 | 45-60 |
| Potato products, frozen | | | | | |
| Potato rösti | Universal pan | 3 |  | 200-220 | 25-35 |
| Potato pockets, filled | Universal pan | 3 |  | 190-210 | 20-30 |
| Croquettes | Universal pan | 3 |  | 200-220 | 25-35 |
| Chips | Universal pan | 3 |  | 190-210 | 25-35 |
| Chips, 2 levels | Universal pan + baking tray | 3+1 |  | 190-210 | 30-40 |

Yogurt

You can make your own yogurt using your appliance.

Making yoghurt

Remove accessories and shelf supports from the cooking compartment. The cooking compartment must be empty. Do not open the appliance door while the appliance is in operation.

1. Heat 1 litre of milk (3.5% fat) to 90 °C on the hob and then leave it to cool down to 40 °C.

It is sufficient to heat UHT milk to 40 °C.

2. Stir in 150 g (chilled) yoghurt.
3. Pour into cups or small jars and cover with cling film.
4. Place the cups or jars onto the cooking compartment floor and use the settings indicated in the table.
5. After making the yoghurt, leave it to cool in the refrigerator.

Type of heating used:

-  Dough proving

| Dish | Accessories | Shelf position | Type of heating | Temperature in °C | Cooking time in hours |
|--------|-------------------|---------------------------|---|-------------------|-----------------------|
| Yogurt | Individual moulds | Cooking compartment floor |  | 35-40 | 8-9 |

Eco heating functions

CircoTherm eco and Top/bottom heating eco are intelligent heating functions that allow you to gently cook meat, fish and baked items. The appliance optimally controls the supply of energy to the cooking compartment. The food is cooked in phases using residual heat. This means that it remains more succulent and browns less. Depending on the method of preparation and the type of food, it is possible to save energy. If you open the appliance door before the food has finished cooking or if you preheat the appliance, you may not be able to achieve this result.

Only use genuine accessories for your appliance. These have been tailored to the cooking compartment and the operating modes of your appliance. Remove any accessories that are not being used from the cooking compartment.

Place the food into the empty cooking compartment before the oven is heated up. For CircoTherm eco, select a temperature of between 125 and 200 °C, and for Top/bottom heating eco, select a temperature of

between 150 and 250 °C. Always keep the appliance door closed when cooking. Only cook on one level when using this function.

The CircoTherm eco heating function is used to measure both the energy consumption in air recirculation mode and the energy efficiency class. The Top/bottom heating eco heating function is used to measure the energy consumption in the conventional mode.

The CircoTherm eco heating type is used to determine the energy efficiency class.

Accessories

Ensure that you always use suitable accessories and that they are placed in the oven the right way around.

Wire rack

Insert the wire rack with the open side facing the appliance door and the curved lip pointing downwards. Always place ovenware, tins and dishes on the wire rack.

Universal pan or baking tray

Slide the universal pan or the baking tray in carefully as far as the limit stop with the bevelled edge facing the appliance door.

Baking tins and cookware

Dark- coloured metal baking tins are most suitable. These allow you to make energy savings of up to 35 per cent.

Cookware made from stainless steel or aluminium reflects heat like a mirror. Non-reflective cookware made from enamel, heat-resistant glass or coated, die-cast aluminium is more suitable.

Tinplate baking tins, ceramic dishes or glass dishes prolong baking time, and the cake will not brown so evenly.

Greaseproof paper



Only use greaseproof paper that is suitable for the selected temperature. Always cut greaseproof paper to size.

























Recommended setting values



Here, you can find specifications for the various dishes with CircoTherm Eco and Top/bottom heating Eco. The temperature and baking time depend on the consistency and amount of the dough. Settings ranges are indicated for this reason. Try with the lower values first. A lower temperature results in more even browning. You can increase the temperature next time if necessary.

Note: Baking times can not be reduced by using higher temperatures. Cakes or baked items would only be cooked on the outside, but would not be fully cooked in the middle.

Types of heating used:

-  CircoTherm eco
-  Top/bottom heating Eco

| Dish | Accessories/cookware | Shelf position | Type of heating | Temperature in °C | Cooking time in mins. |
|---|-------------------------------------|----------------|---|-------------------|-----------------------|
| Cakes in tins | | | | | |
| Sponge cake in a tin | Ring tin/cake tin | 2 |  | 140-160 | 60-80 |
| Sponge flan base | Flan base tin | 2 |  | 150-170 | 20-30 |
| Sponge base, 2 eggs | Flan base tin | 2 |  | 150-170 | 20-30 |
| Sponge flan, 3 eggs | Springform cake tin, diameter 26 cm | 2 |  | 160-170 | 30-45 |
| Sponge flan, 6 eggs | Springform cake tin, diameter 28 cm | 2 |  | 150-160 | 50-60 |
| Bundt yeast cake | Ring cake tin | 2 |  | 150-170 | 50-70 |
| Cakes on baking trays | | | | | |
| Sponge cake with dry topping | Baking tray | 3 |  | 150-170 | 25-40 |
| Shortcrust tart with dry topping | Baking tray | 3 |  | 170-180 | 25-35 |
| Swiss roll | Baking tray | 3 |  | 180-190 | 15-20 |
| Plaited loaf, savarin | Baking tray | 3 |  | 160-170 | 25-35 |
| Yeast cake with dry topping | Baking tray | 3 |  | 160-180 | 15-20 |
| Small baked items | | | | | |
| Muffins | Muffin tray | 2 |  | 160-180 | 15-25 |
| Small cakes | Baking tray | 3 |  | 150-160 | 25-35 |
| Puff pastry | Baking tray | 3 |  | 170-190 | 20-35 |
| Choux pastry | Baking tray | 3 |  | 190-200 | 40-50 |
| Biscuits | Baking tray | 3 |  | 140-160 | 15-30 |
| Whirls | Baking tray | 3 |  | 140-150 | 25-35 |
| Small yeast cakes | Baking tray | 3 |  | 160-180 | 25-35 |
| Bread and bread rolls | | | | | |
| Multigrain bread, 1.5 kg | Cake tin | 2 |  | 200-210 | 35-45 |
| Flatbread | Universal pan | 3 |  | 250-275 | 15-20 |
| Bread rolls, sweet, fresh | Baking tray | 3 |  | 170-190 | 15-20 |
| Bread rolls, fresh | Baking tray | 3 |  | 180-200 | 20-30 |
| Meat | | | | | |
| Joint of pork without rind, e.g. neck, 1.5 kg | Cookware, uncovered | 2 |  | 180-190 | 120-140 |
| Pot-roasted beef, 1.5 kg | Cookware, covered | 2 |  | 200-220 | 140-160 |
| Joint of veal, 1.5 kg | Cookware, uncovered | 2 |  | 170-180 | 110-130 |

| Dish | Accessories/cookware | Shelf position | Type of heating | Temperature in °C | Cooking time in mins. |
|--|----------------------|----------------|---|-------------------|-----------------------|
| Fish | | | | | |
| Fish, braised, whole 300 g, e.g. trout | Cookware, covered | 2 |  | 190-210 | 25-35 |
| Fish, braised, whole 1.5 kg, e.g. salmon | Cookware, covered | 2 |  | 190-210 | 45-55 |
| Fish fillet, plain, braised | Cookware, covered | 2 |  | 190-210 | 15-25 |

Acrylamide in foodstuffs

Acrylamide is mainly produced in grain and potato products prepared at high temperatures, such as potato

crisps, chips, sliced bread, bread rolls, bread or fine baked goods (biscuits, gingerbread, spiced biscuit).

| Tips for keeping acrylamide to a minimum | |
|--|---|
| General | <ul style="list-style-type: none"> ■ Keep cooking times as short as possible. ■ Cook food until it is golden brown, but not too dark. ■ Large, thick pieces of food contain less acrylamide. |
| Baking | <p>With top/bottom heating at max. 200 °C.</p> <p>With hot air at max. 180 °C.</p> |
| Biscuits | <p>With top/bottom heating at max. 190 °C.</p> <p>With hot air at max. 170 °C.</p> <p>Egg or egg yolk reduces the production of acrylamide.</p> |
| Oven chips | <p>Spread out a single layer evenly on the baking tray. Cook at least 400 g at once on a baking tray so that the chips do not dry out.</p> |

Slow cook

Slow cooking is a technique for cooking food over a long period at low temperatures. For this reason, it is also called "low-temperature cooking".

Slow cooking is ideal for all prime cuts (e.g. tender portions of beef, veal, pork, lamb or poultry) which are to be cooked "à point". The meat will remain succulent and tender.

The benefit of this cooking method is that it allows lots of scope for menu planning because slow-cooked meat is easy to keep warm. You do not have to turn the meat when cooking. Keep the appliance door closed in order to maintain an even cooking climate.

Only use fresh, clean and hygienic meat without bones. Carefully remove sinews and fat from around the edge. Fat develops a strong, distinct flavour during slow cooking. You can also use seasoned or marinated meat. Do not use defrosted meat.

Meat can be carved immediately following slow cooking. No standing time is required. Due to the special cooking method, the meat looks pink, but is not raw or undercooked.

Note: Delayed-start operation with an end time is not possible for the slow cooking heating type.

Cookware

Use shallow cookware, e.g. a glass/porcelain serving dish. Place the cookware into the cooking compartment to preheat it.

Always place the uncovered cookware onto the wire rack at level 2.

You can find additional information in the tips on slow cooking attached to the settings table.

Your appliance features the heating type "Slow cook". Only start operation when the cooking compartment has fully cooled down. Allow the cooking compartment to warm up for approx. 15 minutes with the cookware inside.















Sear the meat on the hotplate at a very high heat and for a sufficiently long time on all sides, even on the ends. Place into the preheated cookware right away. Place the cookware containing the meat into the cooking compartment once again and cook slowly.

Recommended setting values

The slow cooking temperature and cooking time are dependent on the size, thickness and quality of the meat. Different settings ranges are indicated for this reason.

Type of heating used:

-  Low temperature cooking

| Dish | Cookware | Shelf position | Heating function | Searing time in mins | Temperature in °C | Cooking time in mins |
|--|---------------------|----------------|--|----------------------|-------------------|----------------------|
| Poultry | | | | | | |
| Duck breast, medium rare, 300 g each | Cookware, uncovered | 2 |  | 6-8 | 90* | 45-60 |
| Chicken breast fillet, 200 g each, well done | Cookware, uncovered | 2 |  | 4 | 120* | 45-60 |
| Turkey breast, boned, 1 kg, well done | Cookware, uncovered | 2 |  | 6-8 | 120* | 110-130 |
| Pork | | | | | | |
| Pork tenderloin steak, 5-6 cm thick, 1.5 kg | Cookware, uncovered | 2 |  | 6-8 | 80* | 130-180 |
| Fillet of pork, whole | Cookware, uncovered | 2 |  | 4-6 | 80* | 45-70 |
| Beef | | | | | | |
| Joint of beef (rump), 6-7 cm thick, 1.5 kg | Cookware, uncovered | 2 |  | 6-8 | 100* | 150-180 |
| Fillet of beef, 1 kg | Cookware, uncovered | 2 |  | 4-6 | 80* | 90-120 |
| Sirloin, 5-6 cm thick | Cookware, uncovered | 2 |  | 6-8 | 80* | 120-180 |
| Beef medallions/rump steak, 4 cm thick | Cookware, uncovered | 2 |  | 4 | 80* | 30-60 |
| Veal | | | | | | |
| Joint of veal, 4-5 cm thick, 1.5 kg | Cookware, uncovered | 2 |  | 6-8 | 80* | 80-140 |
| Joint of veal, 7-10 cm thick, 1.5 kg | Cookware, uncovered | 2 |  | 6-8 | 80* | 140-200 |
| Fillet of veal, whole, 800 g | Cookware, uncovered | 2 |  | 4-6 | 80* | 70-120 |
| Veal medallions, 4 cm thick | Cookware, uncovered | 2 |  | 4 | 80* | 30-50 |
| Lamb | | | | | | |
| Saddle of lamb, boneless, 200 g each | Cookware, uncovered | 2 |  | 4 | 80* | 30-45 |
| Leg of lamb, boned, medium, 1 kg, tied | Cookware, uncovered | 2 |  | 6-8 | 95* | 120-180 |
| * Preheat | | | | | | |

Tips for slow cooking

| | |
|--|---|
| Slow-cooking duck breast. | Place the cold duck breast into a pan and fry the skin side first. After slow cooking, grill for 3 to 5 minutes until crispy. |
| The slow-cooked meat is not as hot as conventionally roasted meat. | So that the roasted meat does not cool so quickly, warm the plates and serve the sauces very hot. |

Drying

You can achieve outstanding drying results with CircoTherm. With this type of preserving, flavourings are concentrated by the dehydration.

Only use unblemished fruit, vegetables and herbs and wash them thoroughly. Line the wire rack with greaseproof paper or parchment paper. Drain the excess water from the fruit and dry it.

If necessary, cut it into equal chunks or thin slices. Place unpeeled fruit onto the dish with the sliced surfaces facing upwards. Ensure that neither fruit nor mushrooms overlap on the wire rack.

Grate vegetables and then blanch them. Allow the blanched vegetables to drain off and distribute them evenly on the wire rack.

Dry herbs on the stem. Position the herbs evenly and slightly heaped on the wire rack.

Use the following shelf positions for drying:

- 1 wire rack: Level 3
- 2 wire racks: Level 3+1

Turn very juicy fruit and vegetables several times. After drying, remove the dried products from the paper immediately.





Recommended setting values

In the table, you can find settings for drying various foodstuffs. The temperature and cooking time are dependent on the type, moisture, ripeness and thickness of the food to be dried. The longer you leave the food to be dried, the better it will be preserved. The thinner the slices are, the quicker the drying process will be and the more aromatic the dried food will remain. Setting ranges are indicated for this reason.

If you wish to dry additional foodstuffs, you should use similar foodstuffs in the table as a reference.

Type of heating used:

-  CircoTherm

| Fruit, vegetables and herbs | Accessories | Type of heating | Temperature in °C | Cooking time in hours |
|--|----------------|---|-------------------|-----------------------|
| Pomes (apple rings, 3 mm thick, 200 g per wire rack) | 1-2 wire racks |  | 80 | 5-9 |
| Stone fruit (plums) | 1-2 wire racks |  | 80 | 8-10 |
| Root vegetables (carrots), grated, blanched | 1-2 wire racks |  | 80 | 5-8 |
| Sliced mushrooms | 1-2 wire racks |  | 60 | 6-9 |
| Herbs, washed | 1-2 wire racks |  | 60 | 2-6 |

Preserving

You can preserve fruit and vegetables using your appliance.

Warning – Risk of injury!

If the food is preserved incorrectly, the preserving jars may burst. Follow the instructions for preserving.

Jars

Use only clean and undamaged preserving jars. Only use heat-resistant, clean and undamaged rubber rings. Check clips and clamps in advance.

For each preserving process, only use preserving jars that are the same size and contain the same food. In the cooking compartment, you can preserve the contents of a maximum of six ½, 1 or 1½-litre preserving jars at the same time. Do not use jars that are larger or taller than this. The lids could rupture.

Preserving jars must not touch one another in the cooking compartment during the preserving process.

Preparing fruit and vegetables

Only use fruit and vegetables that are in good condition. Wash them thoroughly.

Peel, core and chop fruit and vegetables appropriate to their type and fill the preserving jars with them up to approx. 2 cm below the rim.

Fruit

Fill the preserving jars with the fruit along with a hot, skimmed sugar solution (approx. 400 ml for a 1-litre jar). For one litre of water:

- Approx. 250 g sugar for sweet fruit
- Approx. 500 g sugar for sour fruit

Vegetables

Fill the jars with the vegetables along with hot, boiled water.

Wipe the rims of the jars, as they must be clean. Place a damp rubber ring and a lid on each jar. Seal the jars with clamps. Place the jars into the universal pan so that they do not touch each other. Pour 500 ml hot water (approx. 80 °C) into the universal pan. Use the settings indicated in the table.

Ending the preserving process

Fruit

After a short while, small bubbles will form at short intervals. Switch off the appliance once all preserving jars are bubbling. Remove the jars from the cooking compartment after the indicated cooling time.

Vegetables

After a short while, small bubbles will form at short intervals. As soon as all preserving jars are bubbling, reduce the temperature to 120 °C and allow the jars to continue to bubble in the closed cooking compartment as indicated in the table. After this time has elapsed, switch off the appliance and make use of the residual heat for several minutes as indicated in the table.



After preserving, remove the jars from the cooking compartment and place them onto a clean cloth. Do not place these hot jars onto a cold or damp surface, as they may crack. Cover the preserving jars to protect them from draughts. Only remove the clamps once the jars are cold.



Recommended setting values

The indicated times in the settings table are average values for preserving fruit and vegetables. They may be influenced by room temperature, the number of jars, quantity, heat and quality of the jar contents. The specifications are based on 1-litre round jars. Before you switch off the appliance or change the cooking mode, check whether the contents of the jars are bubbling as they should. The bubbling process starts after approx. 30-60 minutes.

Type of heating used:

-  CircoTherm

| Preserving | Cookware | Shelf position | Type of heating | Temperature in °C | Cooking time in mins. |
|----------------------------|-------------------------|----------------|---|-------------------|----------------------------------|
| Vegetables, e.g. carrots | 1-litre preserving jars | 1 |  | 160-170 | Before it starts bubbling:30-40 |
| | | | | 120 | When it starts to bubble: 30-40 |
| | | | | - | Residual heat: 30 |
| Vegetables, e.g. cucumbers | 1-litre preserving jars | 1 |  | 160-170 | Before it starts bubbling: 30-40 |
| | | | | - | Residual heat: 30 |

| Preserving | Cookware | Shelf position | Type of heating | Temperature in °C | Cooking time in mins. |
|-------------------------------------|-------------------------|----------------|---|-------------------|---------------------------------|
| Stone fruit, e.g. cherries, damsons | 1-litre preserving jars | 1 |  | 160-170 | Before it starts bubbling:30-40 |
| | | | | | Residual heat:35 |
| Pomes, e.g. apples, strawberries | 1-litre preserving jars | 1 |  | 160-170 | Before it starts bubbling:30-40 |
| | | | | | Residual heat: 25 |

Allowing the dough to prove at dough proving setting

Yeast dough will prove considerably more quickly using the "Dough proving" heating type than at room temperature and does not dry out. Only start operation when the cooking compartment has fully cooled down.

Always allow yeast dough to prove twice. Observe the specifications in the settings tables for the 1st and 2nd proving processes (dough fermentation and final fermentation).

Dough fermentation

Pour 200 ml water onto the cooking compartment floor for the dough fermentation.

Caution!

Surface damage

- Never pour water into the hot cooking compartment. The temperature change can cause damage to the enamel.
- Do not use distilled water. Use tap water only.

Place the dough into a heat-resistant bowl and place it onto the wire rack. Use the settings indicated in the table.

Do not open the appliance door during the proving process, as moisture will escape. Do not cover the dough.

Condensation builds during operation which steams up the door pane. Wipe out the cooking compartment after dough proving. Loosen any limescale with a little vinegar and wipe with clean water.

Final fermentation

Place your baked item into the oven at the shelf position indicated in the table.





If you want to preheat the oven, the final fermentation takes place outside the appliance in a warm place.

Recommended setting values

The temperature and proving time are dependent on the type and quantity of the ingredients. The values in the table are therefore only meant to be average values.

Type of heating used:

-  Dough proving

| Dish | Accessories/cookware | Shelf position | Type of heating | Step | Temperature in °C | Cooking time in mins. |
|-----------------------------|----------------------|----------------|--|--------------------|-------------------|-----------------------|
| Yeast dough, light | Bowl | 2 |  | Dough fermentation | 35-40 | 25-30 |
| | Baking tray | 2 |  | Final fermentation | 35-40 | 10-20 |
| Yeast dough, heavy and rich | Bowl | 2 |  | Dough fermentation | 35-40 | 20-40 |
| | Baking tray | 2 |  | Final fermentation | 35-40 | 15-25 |

Defrosting

Use heating type "CircoTherm" to defrost frozen fruit, vegetables and baked items. Poultry, meat and fish should ideally be defrosted in the refrigerator.

Use the following shelf positions when defrosting:

- 1 wire rack: Level 2
- 2 wire racks: Level 3+1

Recommended setting values

The times in the table are average values. They are dependent on the quality, freezing temperature (-18 °C) and composition of the food. Time ranges are indicated. Set the shortest time first and then extend the time if necessary.

Tip: Items which were frozen flat or portioned defrost faster than those frozen in a block.



Remove frozen food from the packaging and place it in suitable cookware onto the wire rack.

Stir the food or turn it once or twice in between. Large pieces of food should be turned several times. Occasionally split the food or remove items which have already defrosted from the cooking compartment.

Leave the defrosted food to rest for another 10 to 30 minutes in the appliance whilst it is switched off, so that the temperature balances out.

Type of heating used:

-  CircoTherm

| Dish | Accessories | Shelf position | Type of heating | Temperature in °C | Cooking time in mins. |
|-----------------------------|-------------|----------------|---|-------------------|-----------------------|
| Bread, bread rolls | | | | | |
| Bread & bread rolls general | Baking tray | 2 |  | 50 | 40-70 |
| Cake | | | | | |
| Cake, moist | Baking tray | 2 |  | 50 | 70-90 |
| Cake, dry | Baking tray | 2 |  | 60 | 60-75 |

Keeping warm

You can keep cooked dishes warm using the top/bottom heating type at 70 °C. This will avoid condensation developing, and means you will not have to wipe out the cooking compartment.

Do not keep cooked dishes warm for longer than two hours. Be aware that some dishes may continue cooking whilst being kept warm. Cover the dishes if necessary.

Test dishes

These tables have been produced for test institutes to facilitate appliance testing.

As per EN 60350-1.

Baking

Baked items that are placed into the oven on trays or in baking tins/dishes at the same time will not necessarily be ready at the same time.

Shelf positions for baking on two levels:

- Universal pan: Level 3
Baking tray: Level 1
- Baking tins/dishes on the wire rack
First wire rack: Level 3
Second wire rack: Level 1

Shelf positions for baking on three levels:

- Baking tray: Level 4
- Universal pan: Level 3
- Baking tray: Level 1

Apple pie

Apple pie on one level: place dark-coloured springform cake tins diagonally next to each other.

Apple pie on two levels: position dark-coloured springform cake tins above each other so that they are offset.

Cakes in tinplate springform cake tins: bake on one level with top/bottom heating. Place the springform cake tin onto the universal pan instead of onto the wire rack.



Fatless sponge cake

Fatless sponge cake on two levels: vertically stack springform cake tins in an offset manner on the wire racks.







Notes

- The setting values apply to dishes placed into a cold cooking compartment.
- Please note the information in the tables about preheating. The setting values are valid without rapid heating-up.
- For baking, use the lower of the indicated temperatures first.

Types of heating used:

-  CircoTherm
-  Top/bottom heating
-  CircoTherm intensive

| Dish | Accessory | Shelf position | Type of heating | Temperature in °C | Cooking time in mins. |
|--|------------------------------|----------------|---|-------------------|-----------------------|
| Baking | | | | | |
| Shortbread | Baking tray | 3 |  | 140-150* | 25-40 |
| Shortbread | Baking tray | 3 |  | 140-150* | 25-40 |
| Shortbread, 2 levels | Universal pan + baking tray | 3+1 |  | 140-150* | 30-40 |
| Shortbread, 3 levels | Baking trays + universal pan | 4+3+1 |  | 130-140* | 35-55 |
| Small cakes | Baking tray | 3 |  | 160* | 20-30 |
| Small cakes | Baking tray | 3 |  | 150* | 25-35 |
| Small cakes, 2 levels | Universal pan + baking tray | 3+1 |  | 150* | 25-35 |
| * Preheat for 5 mins, do not use quick heat function | | | | | |
| ** Preheat, do not use quick heat function | | | | | |

| Dish | Accessory | Shelf position | Type of heating | Temperature in °C | Cooking time in mins. |
|-------------------------------|--------------------------------------|----------------|---|-------------------|-----------------------|
| Small cakes, 3 levels | Baking trays + universal pan | 4+3+1 |  | 140* | 35-45 |
| Fatless sponge cake | Springform cake tin, diameter 26 cm | 2 |  | 160-170** | 25-35 |
| Fatless sponge cake | Springform cake tin, diameter 26 cm | 2 |  | 160-170** | 30-40 |
| Fatless sponge cake, 2 levels | Springform cake tin, diameter 26 cm | 3+1 |  | 150-170** | 30-50 |
| Apple pie | 2 x black plate tins, diameter 20 cm | 2 |  | 170-180 | 60-80 |
| Apple pie | 2 x black plate tins, diameter 20 cm | 2 |  | 180-200 | 60-80 |
| Apple pie, 2 levels | 2 x black plate tins, diameter 20 cm | 3+1 |  | 170-190 | 70-90 |

* Preheat for 5 mins, do not use quick heat function

** Preheat, do not use quick heat function

Grilling

Also slide in the universal pan. The liquid will be caught and the cooking compartment stays cleaner.

Type of heating used:

■  Full-surface grill

| Dish | Accessories | Shelf position | Type of heating | Temperature in °C | Cooking time in mins. |
|-------------------------|-------------|----------------|---|-------------------|-----------------------|
| Grilling | | | | | |
| Toasting bread* | Wire rack | 4 |  | 290 | 4-6 |
| Beefburger, 12 pieces** | Wire rack | 4 |  | 290 | 25-30 |

* Do not preheat

** Turn after 2/3 of the total time



REGISTER YOUR PRODUCT
ONLINE NEFF-HOME.COM



Constructa NEFF Vertriebs-GmbH |
Carl-Wery-Straße 34 | 81739 Munich | Germany

9001331216
980126
en